

# TESTEQUITY

## Model 3007C FastRate™ Temperature Chamber With F4 Controller and EZ-Zone Limit Controller

### Operation and Service Manual



**TestEquity LLC**  
6100 Condor Drive  
Moorpark, CA 93021

Support: 877-512-3457 Toll Free  
805-480-0638

Corporate: 800-732-3457  
805-498-9933

<http://www.testequity.com>



---

---

## Table of Contents

---

---

|  |             |
|--|-------------|
| <b>Chapter 1 – Safety Instructions</b>                   | <b>1-1</b>  |
| <b>Introduction</b>                                      | <b>1-1</b>  |
| <b>Installation Safety Notices</b>                       | <b>1-1</b>  |
| <b>Operation Safety Notices</b>                          | <b>1-3</b>  |
| <b>Chapter 2 – Installation</b>                          | <b>2-1</b>  |
| <b>Uncrating</b>   | <b>2-1</b>  |
| <b>Preparation For Use</b>                               | <b>2-1</b>  |
| <b>Installation Location</b>                             | <b>2-1</b>  |
| <b>Condensate Drain</b>                                  | <b>2-2</b>  |
| <b>Input Power Configuration</b>                         | <b>2-2</b>  |
| <b>Connection to the Power Source</b>                    | <b>2-3</b>  |
| Power Source Connection                                  | 2-3         |
| Phase Sequence   | 2-3         |
| <b>LN2 (Liquid Nitrogen) Installation (Option 0018)</b>  | <b>2-4</b>  |
| <b>Chapter 3 – Operation</b>                             | <b>3-1</b>  |
| <b>Introduction</b>                                      | <b>3-1</b>  |
| <b>Summary of Chamber Operation</b>                      | <b>3-1</b>  |
| <b>Front Panel Switches and Lights</b>                   | <b>3-2</b>  |
| Main Disconnect Switch                                   | 3-2         |
| Conditioning Switch – ON Mode                            | 3-2         |
| Conditioning Switch – Event 1 Mode                       | 3-2         |
| Light Switch   | 3-3         |
| Heat Light   | 3-3         |
| Cool Light   | 3-3         |
| <b>Loading the Chamber</b>                               | <b>3-4</b>  |
| Port Plugs   | 3-4         |
| Performance Considerations                               | 3-5         |
| Avoiding Moisture  | 3-5         |
| Internal Test Fixtures                                   | 3-5         |
| <b>Chapter 4 - Temperature Controller</b>                | <b>4-1</b>  |
| <b>Introduction</b>                                      | <b>4-1</b>  |
| Security Features  | 4-1         |
| <b>Temperature Controller Keys and Displays</b>          | <b>4-2</b>  |
| <b>Main Page</b>   | <b>4-3</b>  |
| System Enable Function                                   | 4-4         |
| Static Set Point Control                                 | 4-5         |
| <b>Boost Heat</b>  | <b>4-5</b>  |
| <b>LN2 (Liquid Nitrogen) Boost Cooling (Option 0018)</b> | <b>4-6</b>  |
| <b>Profile Programming</b>                               | <b>4-7</b>  |
| Step Types   | 4-7         |
| How to Program a New Profile                             | 4-9         |
| Programming Hints  | 4-10        |
| Profile Key  | 4-10        |
| How to Start a Profile                                   | 4-10        |
| How to Hold/Resume a Running Profile                     | 4-11        |
| How to Terminate a Running/Holding Profile               | 4-11        |
| How to Delete or Re-Name a Profile                       | 4-11        |
| How to Edit a Profile                                    | 4-12        |
| Profile Example  | 4-13        |
| <b>Digital Event Outputs</b>                             | <b>4-14</b> |
| Event Relays   | 4-14        |
| <b>Operations Page</b>                                   | <b>4-15</b> |
| <b>Setup Page</b>  | <b>4-15</b> |

---

---

## Table of Contents

---

---

|  |             |
|--|-------------|
| <b>Factory Page</b>                                      | <b>4-16</b> |
| <b>Computer Interface</b>                                | <b>4-17</b> |
| RS-232C  | 4-17        |
| Common Modbus Registers                                  | 4-17        |
| GPIB (optional)  | 4-17        |
| Ethernet (optional)                                      | 4-17        |
| <b>Chapter 5 - Limit Controller</b>                      | <b>5-1</b>  |
| <b>Introduction</b>                                      | <b>5-1</b>  |
| Limit Controller Keys and Displays                       | 5-2         |
| How to Set the High and Low Temperature Safety Limits    | 5-2         |
| Resetting an Out of Limit Condition                      | 5-2         |
| Silencing the Audible Alarm                              | 5-2         |
| Protecting an Energized Test Sample                      | 5-3         |
| <b>Chapter 6 – Frequently Asked Questions</b>            | <b>6-1</b>  |
| <b>Chapter 7 – Specifications</b>                        | <b>7-1</b>  |
| <b>Model 3007C Chamber Specifications</b>                | <b>7-1</b>  |
| <b>F4 Temperature Controller Specifications</b>          | <b>7-2</b>  |
| <b>Chapter 8 – Maintenance</b>                           | <b>8-1</b>  |
| <b>Preventive Maintenance Intervals</b>                  | <b>8-1</b>  |
| <b>Maintenance Procedures</b>                            | <b>8-2</b>  |
| How to clean the chamber interior and exterior           | 8-2         |
| How to listen for abnormal noise or vibration            | 8-2         |
| How to inspect the door seal                             | 8-2         |
| How to inspect the refrigeration machinery compartment   | 8-3         |
| How to check the low-stage refrigerant charge            | 8-3         |
| How to check the high-stage refrigerant charge           | 8-3         |
| How to verify the chamber performance                    | 8-4         |
| How to inspect the electrical compartment                | 8-5         |
| How to clean the condenser                               | 8-5         |
| How to verify the calibration                            | 8-5         |
| <b>Theory of Operation</b>                               | <b>8-6</b>  |
| Overview   | 8-6         |
| Heating System   | 8-6         |
| Refrigeration System                                     | 8-6         |
| <b>Troubleshooting</b>                                   | <b>8-8</b>  |
| <b>Refrigeration System Charging Instructions</b>        | <b>8-10</b> |
| R-404A High-Stage Charge                                 | 8-10        |
| R-508B Low-Stage Charge                                  | 8-10        |
| <b>Recommended Spare Parts</b>                           | <b>8-11</b> |
| <b>Major Electrical Parts</b>                            | <b>8-12</b> |
| <b>Major Refrigeration Parts</b>                         | <b>8-13</b> |
| <b>LN2 Parts (opt. 0018)</b>                             | <b>8-13</b> |
| <b>General Parts</b>                                     | <b>8-13</b> |
| <b>Series F4 Temperature Controller Setup Parameters</b> | <b>8-14</b> |
| Series F4 Setup Parameters                               | 8-15        |
| Series F4 Operations Parameters                          | 8-16        |
| Series F4 Set Lockout Parameters                         | 8-16        |
| <b>EZ-Zone Limit Controller Setup Parameters</b>         | <b>8-17</b> |
| <b>Chapter 9 - Warranty</b>                              | <b>9-1</b>  |
| <b>Chapter 10 – Drawings</b>                             | <b>10-1</b> |

## Chapter 1 – Safety Instructions

### ***Introduction***

---

Follow all CAUTION notices to prevent damage to the chamber or your test sample. Failure to follow all CAUTION notices may void your warranty. CAUTION may also indicate a potentially hazardous situation which, if not avoided, may result in minor or moderate personal injury.

WARNING indicates a potentially hazardous situation which, if not avoided, could result in death or serious injury.

The safety alert symbol  precedes a general CAUTION or WARNING statement.

The electrical hazard symbol  precedes an electric shock hazard CAUTION or WARNING statement.

### ***Installation Safety Notices***

---

 **CAUTION:** The minimum clearance you should allow for proper ventilation around the chamber must be at least 12" from both the left and right side, and 24" from the rear.

 **CAUTION:** This chamber is designed for operation in a conditioned laboratory environment. Operation above 30°C (85°F) or below 16°C (60°F) ambient room temperature is NOT recommended.

 **CAUTION:** The Input Voltage label on the back of the chamber indicates the input voltage configuration as shipped from the factory. If the input voltage configuration is changed, this label must be replaced to reflect the new configuration. Replacement labels are available from TestEquity at no charge.

 **CAUTION:** This chamber must be properly configured for either 208 V or 230 V (240 V) nominal input. 208 V and 230 V (240 V) are NOT the same. Do NOT guess! Do NOT assume you have “220 V”. You must verify the exact type of electrical service you have. If there is any doubt, you must consult with a qualified electrician who is familiar with industrial plant wiring. In addition, the input line voltage should be measured while the chamber is operating in a continuous HEAT mode to ensure that the expected nominal voltage of either 208 V  $-5/+10\%$  or 230 V  $\pm 10\%$  is present.

 **CAUTION:** This chamber should be connected to the AC power source by a qualified electrician who is familiar with industrial plant wiring.

- ⚠ WARNING:** Liquid nitrogen is extremely cold ( $-190^{\circ}\text{C}$  or  $-320^{\circ}\text{F}$ ). It can cause severe burns, frostbite, or eye damage. When handling liquid nitrogen containers or piping; wear goggles for eye protection, protective clothing, and thick impervious gloves (such as welder's leather).
- ⚠ WARNING:** The connecting tube must include a relief valve designed for use with liquid nitrogen if a manual or automatic isolation valve is present at your source of supply or at any point between the source and the connection point on the back of the 3007C Chamber. This relief valve must be rated for at least 35 psig and less than 100 psig. It is needed to prevent excessive pressure from developing when the nitrogen in the connecting line evaporates during off cycles. Care should be exercised in sighting the relief valve to assure that should it relieve, the effluent will not discharge towards operating personnel.
- ⚠ WARNING:** All liquid nitrogen connecting piping or tubing must be well insulated with appropriate vapor sealed or vacuum jacketed materials. Un-insulated nitrogen connecting lines can condense pure oxygen on their surface since liquid nitrogen is colder than liquid oxygen. Liquid oxygen can present a spontaneous fire hazard when spilled onto organic materials.
- ⚠ WARNING:** Nitrogen gas is heavier than air. It makes up about 78% of the Earth's standard atmosphere, is non-toxic, colorless, odorless, and tasteless. Pure nitrogen gas in a closed area can present an asphyxiation hazard (suffocation) without warning.

### ***Operation Safety Notices***

---

- ⚠ **CAUTION:** This chamber has a crankcase heater to protect the high-stage compressor. The chamber must be connected to the power source AND the Main Disconnect Switch must be ON for 3 hours prior to operating the chamber. Although it may be safe to use the chamber immediately, this procedure ensures the longest possible life for the high-stage compressor if the chamber has been removed from the power source for more than 24 hours.
- ⚠ **CAUTION:** The “Series F4 User’s Manual” is a general manual and is written by the manufacturer, Watlow, for a wide variety of applications and configurations. Not all features or functions are applicable. Only the capabilities of a model F4SH-CKA0-01, as described on page A.7 of the “Series F4 User’s Manual” are applicable. “Cascade Control” as described on page 3.6 of the “Series F4 User’s Manual” is not applicable in this configuration. The “Retransmit” function is available as an option.
- ⚠ **CAUTION:** The Series F4 “Alarm” functions are NOT used in the chamber’s safety system and are NOT connected. TestEquity does NOT recommend using the Series F4 alarm function as the main protection device. The independent EZ-Zone Limit Controller functions as the main protection device.
- ⚠ **CAUTION:** The Series F4 Temperature Controller has been properly configured by TestEquity to match the chamber’s system requirements and to perform optimally over a wide range of operating conditions. Improper modifications to these setup values can result in erratic performance and unreliable operation. Setup examples in the “Series F4 User’s Manual” are NOT applicable to this chamber. Do not attempt to modify the setup values, unless you thoroughly understand what you are doing. If there is any doubt, please call TestEquity before proceeding.
- ⚠ **CAUTION:** NEVER select “Full Defaults” in the Series F4 Controller’s Factory/Test Menu. This will erase all the correct values which are documented in the “Series F4 Temperature Controller Setup Parameters” section of this manual.
- ⚠ **CAUTION:** The EZ-Zone Limit Controller has been properly configured by TestEquity to match the chamber’s system requirements. Improper modifications to these setup values can result in unreliable and unsafe operation. Do not attempt to modify the setup values, unless you thoroughly understand what you are doing. The correct values are documented in the “EZ-Zone Limit Controller Setup Parameters” section of this manual.
- ⚠ **CAUTION:** Always verify that the Limit Controller’s high and low limits are set to temperatures that are appropriate for your test sample.

---

## Chapter 1 – Safety

---

- △ **CAUTION:** If your test sample is energized, it may be capable of raising the workspace temperature beyond safe limits. This could occur if your test sample exceeds the live load rating of the chamber or if the chamber's refrigeration system fails. This chamber has a set of contacts that can be used to remove power to your test sample if the Limit Controller's temperature limits are exceeded.
  
- △ **CAUTION:** To prevent damage to your test sample and the chamber's compressors, do not exceed the live load rating of the chamber.
  
- △ **WARNING:** Do NOT put items in the chamber that could burn or explode at high temperatures. This chamber uses open wire heating elements which generate surface temperatures over 1000°F. This is NOT an explosion-proof chamber.
  
- △ **WARNING:** Do NOT put items in the chamber which can emit corrosive vapors or substances.
  
- △ **WARNING:** This chamber is NOT a curing oven. There are NO provisions for venting fumes.
  
- △ **WARNING:** The chamber door must remain closed while the chamber is operating. If you need to open the door while the chamber is operating, wear safety goggles to prevent the high velocity airflow from blowing particles or objects into your eyes.
  
- △ **WARNING:** This chamber operates at extreme temperatures. Avoid contact with air, objects, and surfaces that are hot or cold to prevent severe burns or frostbite. Protective gloves are recommended.

## Chapter 2 – Installation

### ***Uncrating***

---

Inspect the shipping container for any signs of visible damage. Notify the carrier and TestEquity immediately if there are signs of shipping damage.

The pallet is designed with ramps so the chamber can be rolled off without the need for a forklift or pallet jack.

### ***Preparation For Use***

---

1. Inspect the chamber for signs of shipping damage.
2. Read this entire manual.
3. Select a suitable location to install the chamber.
4. Verify the input voltage configuration.
5. Connect to the power source.
6. Perform following the procedures as described in the Preventive Maintenance section:
  - a. Inspect the electrical compartment.
  - b. Inspect the refrigeration machinery compartment.
  - c. Check the low-stage refrigeration charge.
  - d. Check the high-stage refrigeration charge.
  - e. Verify the chamber performance.

### ***Installation Location***

---

The chamber will produce a significant amount of heat during normal operation. Locate the chamber in a room with adequate ventilation to prevent excessive heat build-up. Allow enough space around the chamber to permit serviceability and the removal of the service access panels, which are located on each side and the rear.

The chamber must be on a solid and level floor.

**△ CAUTION:** The minimum clearance you should allow for proper ventilation around the chamber must be at least 12" from both the left and right side, and 24" from the rear.

**△ CAUTION:** This chamber is designed for operation in a conditioned laboratory environment. Operation above 30°C (85°F) or below 16°C (60°F) ambient room temperature is NOT recommended.

## Condensate Drain

The chamber has a condensate drain connection on the rear of the chamber. This provides a way to remove condensate that may accumulate in the chamber during low-to-high temperature cycling or when the refrigeration system runs to maintain moderate temperatures. Any time the ambient air is subjected to temperatures below the dew point, moisture will condense out of the air. The effect is ice or frost during low temperature operation. When the chamber is heated above 0°C, the ice or frost will turn into water. The fitting accommodates a ½-inch male pipe thread. The chamber drain water is not under pressure, and is fed by gravity. Therefore, it must empty into an open floor drain. Alternatively, the chamber drain can empty into a condensate pump. You can purchase a condensate pump from suppliers such as Grainger ([www.grainger.com](http://www.grainger.com)).

## Input Power Configuration

This chamber can be easily configured for operation from a 208 V / 60 Hz or 230 V (240 V) / 60 Hz, 3 Phase nominal input. Other input voltages and 50 Hz operation are available as special options, and are not covered in these instructions.

Your chamber was configured prior to shipment for the particular voltage that was specified at time of order. These instructions should be used to verify the input voltage configuration prior to installation, or to change the input voltage from one configuration to another.

**⚠ CAUTION:** This chamber must be properly configured for either 208 V or 230 V (240 V) nominal input. 208 V and 230 V (240 V) are NOT the same. Do NOT guess! Do NOT assume you have “220 V”. You must verify the exact type of electrical service you have. If there is any doubt, you must consult with a qualified electrician who is familiar with industrial plant wiring. In addition, the input line voltage should be measured while the chamber is operating in a continuous HEAT mode to ensure that the expected nominal voltage of either 208 V  $-5/+10\%$  or 230 V  $\pm 10\%$  is present.

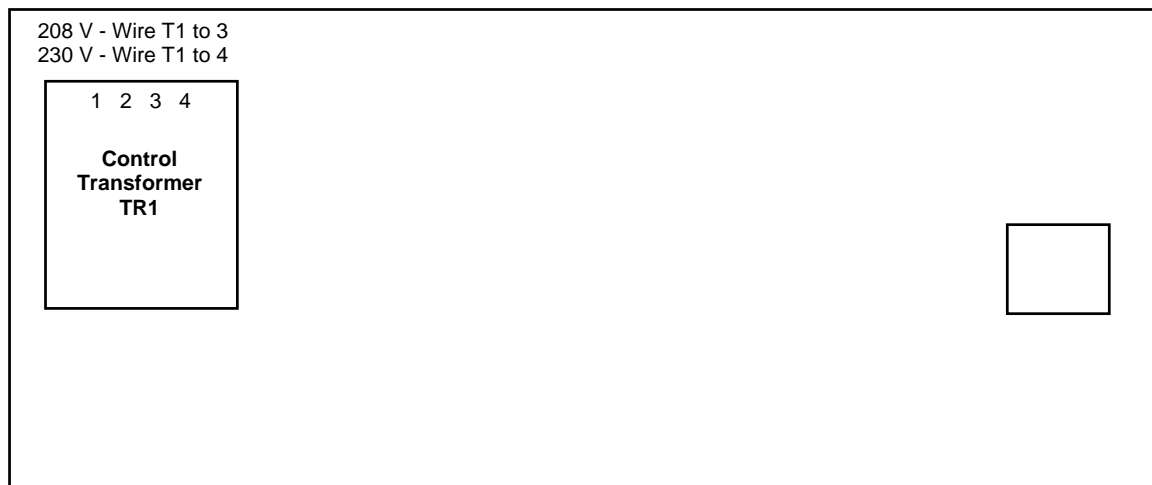

Figure 2-1 – Location of Input Configuration Terminals on the Electrical Sub Panel

**NOTE:** Refer to Figure 2-1 for the location of the input configuration terminals on the electrical sub panel that are described below.

### **230 V / 60 Hz Input Configuration (for 240 V lines)**

1. Turn the Main Disconnect switch to the OFF position.
2. Remove the lower door retaining screw located on the right side. Open the lower door.
3. Locate the Control Transformer TR1. Wire number T1 must be connected to the 230 V terminal 4 on Control Transformer TR1.

### **208 V / 60 Hz Input Configuration**

1. Turn the Main Disconnect switch to the OFF position.
2. Remove the lower door retaining screw located on the right side. Open the lower door.
3. Locate the Control Transformer TR1. Wire number T1 must be connected to the 208 V terminal 3 on Control Transformer TR1.

---

## **Connection to the Power Source**

---

**⚠ CAUTION:** This chamber should be connected to the AC power source by a qualified electrician who is familiar with industrial plant wiring.

The Main Disconnect Switch on the front panel removes primary power to the entire chamber. All branch circuits on the load side of the Main Disconnect Switch are individually fused. However, your local electrical code may require a separate disconnect switch within sight of the chamber.

### **Power Source Connection**

1. Turn the Disconnect Switch to the OFF position.
2. Remove the lower door retaining screw located on the right side. Open the lower door.
3. Remove the chamber's right side panel.
4. Mount the input wire through the hole on the rear of the chamber, using an appropriate bushing. An additional 4-feet of wire will be needed need to reach to the terminals on the electrical subpanel. The wires will need to pass through the Input Access Hole. This hole is located in the corner of the partition which separates the compressor compartment from the electrical compartment. Three tie points are provided on the side of the chamber to secure the input wiring with tie-wraps.
5. Connect the "Hot" input wires to terminals L1, L2 and L3 on the Main Disconnect Switch.
6. Connect the Ground wire (NOT A NEUTRAL) to the Ground terminal.

### **Phase Sequence**

This chamber has a protective circuit to ensure the proper input power phase sequence. If the chamber does not function with the initial wiring hookup, then reverse two of the input lines.

## ***LN2 (Liquid Nitrogen) Installation (Option 0018)***

---

### **Liquid Nitrogen Safety Notices**

- △ **WARNING:** Liquid nitrogen is extremely cold ( $-190^{\circ}\text{C}$  or  $-320^{\circ}\text{F}$ ). It can cause severe burns, frostbite, or eye damage. When handling liquid nitrogen containers or piping; wear goggles for eye protection, protective clothing, and thick impervious gloves (such as welder's leather).
- △ **WARNING:** The connecting tube must include a relief valve designed for use with liquid nitrogen if a manual or automatic isolation valve is present at your source of supply or at any point between the source and the connection point on the back of the 3007C Chamber. This relief valve must be rated for at least 35 psig and less than 100 psig. It is needed to prevent excessive pressure from developing when the nitrogen in the connecting line evaporates during off cycles. Care should be exercised in sighting the relief valve to assure that should it relieve, the effluent will not discharge towards operating personnel.
- △ **WARNING:** All liquid nitrogen connecting piping or tubing must be well insulated with appropriate vapor sealed or vacuum jacketed materials. Un-insulated nitrogen connecting lines can condense pure oxygen on their surface since liquid nitrogen is colder than liquid oxygen. Liquid oxygen can present a spontaneous fire hazard when spilled onto organic materials.
- △ **WARNING:** Nitrogen gas is heavier than air. It makes up about 78% of the Earth's standard atmosphere, is non-toxic, colorless, odorless, and tasteless. Pure nitrogen gas in a closed area can present an asphyxiation hazard (suffocation) without warning.

### **Liquid Nitrogen Installation**

Your chamber may be configured with LN2 Boost Cooling capability. The LN2 system is designed to operate with a low pressure Dewar or low pressure bulk supply system. A customer-provided source of liquid nitrogen at a supply pressure between 10 psig and 75 psig is required for LN2 Boost Cooling.

A high pressure Dewar may be used but the supply must be carefully regulated to less than 75 psig to prevent venting by the chamber's LN2 pressure relief valve which is set for 100 psig. If a high pressure Dewar is used, provide a liquid nitrogen rated relief valve with a setting of not more than 100 psig in the connecting line to relieve pressure in the event that the supply hand valve on the container is manually closed.

The supply connection is on the upper back of the chamber centered between the two fan motors. This connection is a 3/8-inch JIC (Joint Industrial Council) stainless steel 37-degree flare fitting rated for very low temperature operation. The fitting is mounted on a non-metallic thermal breaker to help limit frost formation and condensation.

The recommended connection method from your source of liquid nitrogen is either a length of 3/8-inch OD, ASTM A269, 0.049-inch Wall, Seamless 316 series stainless steel tube terminated on one end with a 37-degree JIC flare fitting and insulated with closed cell, vapor sealed foam; or alternately a commercially manufactured vacuum jacketed liquid nitrogen connecting tube designed for this service. For urethane and polyisocyanurate (Dow Trymer) foam, typical long-term operation liquid nitrogen insulation wall thickness is approximately 2-inches per side (4-inches OD).

If a 3/8-inch OD tube stainless steel tube is selected, the insulation should be installed flush against the non-metallic thermal breaker around the LN2 Inlet fitting on the chamber. If a vacuum jacketed tube is selected, a short adapter may be required to make the final connection to the chamber's LN2 Inlet fitting. For a vacuum jacketed connection, a short ring of closed cell, vapor sealed foam should be applied flush against the thermal breaker on one side and overlapping the vacuum jacket by approximately six inches on the other side.

Support all liquid nitrogen carrying lines with ridged hangers to prevent excessive flexing when cold.

### **Chamber Relief Vent Considerations with Liquid Nitrogen**

For installation in enclosed areas of any size or when ventilation in the room is limited:

- The workspace vent at the top of the chamber must be piped outside of the building to atmosphere with a backpressure-free, vapor-tight, insulated tube.
- The enclosed room must be adequately ventilated to prevent the buildup of nitrogen gas due to leakage, pressure relief valve operation, or chamber door opening.
- An automatic, Low Level Oxygen Alarm must be installed to alert operators of potentially dangerous conditions within the enclosed room. These devices are available from a number of sources. An example is the Chemgard Gas Monitor from MSA (Mine Safety Appliances Company) in Pittsburgh, PA (800-672-2222, [www.msanorthamerica.com](http://www.msanorthamerica.com)).

For installation in large factory areas, with open doors and adequate ventilation certified by a qualified Mechanical Engineer:

- The vent at the top of the chamber can discharge directly into the factory. If desired, the vent can be extended upward approximately two feet with a length of insulated tubing to prevent frost buildup on the top of the chamber.



### Chapter 3 – Operation

#### ***Introduction***

---

The Front Panel Switches control power to the chamber. The Front Panel Lights provide indication of heat and cool functions.

The Limit Controller is a protection device. It turns the chamber OFF if the workspace temperature exceeds either a high temperature or low temperature limit set point.

The Temperature Controller controls the temperature of the chamber. It can function as either a single set point controller or as a programmable profile controller. The Temperature Controller automatically turns the refrigeration system on or off based on the demand for cooling.

**⚠ CAUTION:** This chamber has a crankcase heater to protect the high-stage compressor. The chamber must be connected to the power source AND the Main Disconnect Switch must be ON for 3 hours prior to operating the chamber. Although it may be safe to use the chamber immediately, this procedure ensures the longest possible life for the high-stage compressor if the chamber has been removed from the power source for more than 24 hours.

#### ***Summary of Chamber Operation***

---

1. Turn the Main Disconnect Switch ON.
2. Enter the appropriate high and low temperature safety limits on the Limit Controller.
3. Enter the desired temperature set point (or program) on the Temperature Controller.
4. Load your test sample in the chamber.
5. Turn the Conditioning Switch ON.

### ***Front Panel Switches and Lights***

---

#### **Main Disconnect Switch**

The Main Disconnect Switch (large knob on the front, right side) controls power to the entire chamber and provides a mechanical safety interlock to the lower door.

In the ON position (clockwise) primary power is connected. The Temperature Controller, Limit Controller, and (optional) Chart Recorder are always functional when the Main Disconnect Switch is ON, regardless of the Master Switch position. The Main Disconnect Switch should be left ON if the chamber is usually used on a daily basis.

In the OFF position (counter clockwise) primary power is disconnected. The Main Disconnect Switch can be left OFF if the chamber is not used on a daily basis. It can also be locked in the OFF position with a padlock. The knob has a red insert that can be pushed in at the top to reveal the lock-hole.

**⚠ CAUTION:** This chamber has a crankcase heater to protect the high-stage compressor. The chamber must be connected to the power source AND the Main Disconnect Switch must be ON for 3 hours prior to operating the chamber. Although it may be safe to use the chamber immediately, this procedure ensures the longest possible life for the high-stage compressor if the chamber has been removed from the power source for more than 24 hours.

#### **Conditioning Switch – ON Mode**

The Conditioning Switch enables all chamber functions. When the Conditioning Switch is OFF and the Power switch is ON, only the F4 Controller and Limit Controller are operational. When the Conditioning Switch is ON, the chamber's conditioning system will function to maintain the temperature/humidity set point. The Conditioning Switch does not illuminate.

#### **Conditioning Switch – Event 1 Mode**

When the Conditioning Switch is in the Event 1 position, you can enable and disable all chamber functions through Event 1 (Digital Output 1) of the F4 Controller. When the Conditioning Switch is in the Event 1 position and Event 1 on the F4 Controller is Off, all chamber functions are disabled. If Event 1 is On, all chamber functions are enabled.

See page 4-7 for instructions on how to control the events in manual mode. In profile mode, Event 1 is named **CONDITION**.

**⚠ CAUTION:** Remember to set `DigitalOut 1 (Event Output1)` to On in static set point mode when the chamber is to be operational. In this mode, the Modbus register for Digital Output 1 is 2000.

**⚠ CAUTION:** Remember to set **CONDITION** to On in the profile event prompt for all programmed steps when the chamber is to be operational.

### **Light Switch**

The Light Switch controls the workspace light. The Light Switch illuminates when it is ON.

### **Heat Light**

The Heat Light will illuminate when the Temperature Controller turns on the heater to maintain the workspace temperature. The Heat Light will cycle on/off as the workspace temperature approaches and reaches the temperature set point.

### **Cool Light**

The Cool Light will illuminate when the Temperature Controller turns on the cooling valve to maintain the workspace temperature. The Cool Light will cycle on/off as the workspace temperature approaches and reaches the temperature set point.

### ***Loading the Chamber***

---

- ⚠ **WARNING:** Do NOT put items in the chamber that could burn or explode at high temperatures. This chamber uses open wire heating elements which generate surface temperatures over 1000°F. This is NOT an explosion-proof chamber.
- ⚠ **WARNING:** Do NOT put items in the chamber which can emit corrosive vapors or substances.
- ⚠ **WARNING:** This chamber is NOT a curing oven. There are NO provisions for venting fumes.
- ⚠ **WARNING:** The chamber door must remain closed while the chamber is operating. If you need to open the door while the chamber is operating, wear safety goggles to prevent the high velocity airflow from blowing particles or objects into your eyes.
- ⚠ **WARNING:** This chamber operates at extreme temperatures. Avoid contact with air, objects, and surfaces that are hot or cold to prevent severe burns or frostbite. Protective gloves are recommended.
- ⚠ **CAUTION:** If your test sample is energized, it may be capable of raising the workspace temperature beyond safe limits. This could occur if your test sample exceeds the live load rating of the chamber or if the chamber's refrigeration system fails. This chamber has a set of contacts that can be used to remove power to your test sample if the Limit Controller's temperature limits are exceeded.
- ⚠ **CAUTION:** To prevent damage to your test sample and the chamber's compressors, do not exceed the live load rating of the chamber.

#### **Live Load Capacity for Model 3007C**

|              |               |               |               |               |               |
|--------------|---------------|---------------|---------------|---------------|---------------|
| <b>Temp</b>  | <b>+23°C</b>  | <b>0°C</b>    | <b>-40°C</b>  | <b>-55°C</b>  | <b>-65°C</b>  |
| <b>Watts</b> | <b>3700 W</b> | <b>3500 W</b> | <b>2700 W</b> | <b>2300 W</b> | <b>1800 W</b> |

### **Port Plugs**

Foam port plugs are provided with a gray silicone surface on one side. The port plug must be inserted with the gray silicone surface facing the inside of the chamber. Port plugs should be considered expendable and be replaced when they no longer provide a good seal.

### Performance Considerations

The performance of all chambers is significantly affected by the characteristics of your test sample. Factors include size, weight, material, shape, and power dissipation if energized. The test sample should be placed in the chamber in a manner that allows for air circulation. The air plenum is located on the back wall of the chamber, where air is sucked in from the bottom and exits from the top. You should not place the test sample directly on the chamber floor. It should be placed on the shelf. Multiple test samples should be distributed throughout the chamber to ensure even airflow and minimize temperature gradients. If necessary, additional shelves should be used to evenly distribute the load. Verify that the temperature gradients are within acceptable limits, by measuring the chamber temperature at strategic points using a multipoint thermocouple meter or data logger.

You may find that the temperature throughout the chamber is even, but always different from what the temperature controller indicates. The correct way to adjust what the temperature controller “displays” compared to what is measured at some point other than the controller’s sensor is with the “Calibration Offset” parameter, NOT by recalibrating the controller.

### Avoiding Moisture

Any time the ambient air is subjected to temperatures below the dew point, moisture will condense out of the air. The effect is ice or frost during low temperature operation, or water when maintaining over 0°C and cooling is required.

To avoid moisture condensation, make sure the port plugs are inserted at all times. Also, avoid opening the chamber door while the chamber is operating at temperatures below room ambient. When a low temperature test is completed, warm the chamber to at least room ambient before opening the chamber door and before removing your test sample.

### Internal Test Fixtures

Some applications require internal fixtures to support test samples and provide a convenient method of connecting wires and sensors. Fixtures must be designed to minimize their impact on chamber functionality and performance.

Fixtures should be designed for easy removal to permit maintenance and cleaning of the chamber. The chamber liner should never be drilled or screwed into. This will compromise the integrity of the liner and permit moisture migration due to condensation into the insulation, which will eventually impact performance and lead to premature rusting of the outer cabinet.

Fixtures should be constructed of stainless steel. This also applies to all screws and fasteners. All welds should be passivated. To prevent rust and corrosion, never use iron or mild steel even if it is painted or plated. Aluminum may be used. However, since the specific heat of aluminum is double that of steel, it represents a greater load and will have more impact on the chamber performance.

Make sure that all connectors, wiring, pc boards, and auxiliary components can withstand the temperature extremes that they will be subjected to. In some cases, these components may not be able to last after repeated tests and should be considered expendable.



## Chapter 4 - Temperature Controller

### ***Introduction***

---

The Series F4 Temperature Controller can function as either a single set point controller (static mode) or as a programmable profile controller. A four-line LCD display facilitates setup and programming, and presents informative messages about status, error, and alarm conditions. Digital outputs, profiles, and alarms can be named for easy reference. An Information Key gives you quick information about the pages, menus, parameters and values, as well as error and alarm conditions if they occur. The user-interface is organized into five “pages” of menus.

**⚠ CAUTION:** The Series F4 “Alarm” functions are NOT used in the chamber’s safety system and are NOT connected. TestEquity does NOT recommend using the Series F4 alarm function as the main protection device. The independent EZ-Zone Limit Controller functions as the main protection device.

**⚠ CAUTION:** The Series F4 Temperature Controller has been properly configured by TestEquity to match the chamber’s system requirements and to perform optimally over a wide range of operating conditions. Improper modifications to these setup values can result in erratic performance and unreliable operation. Do not attempt to modify the setup values, unless you thoroughly understand what you are doing. Setup examples in the “Series F4 User’s Manual” are NOT applicable to this chamber. If there is any doubt, please call TestEquity before proceeding. The correct values are documented in the “Series F4 Temperature Controller Setup Parameters” section of this manual.

**⚠ CAUTION:** NEVER select “Full Defaults” in the Series F4 Factory/Test Menu. This will erase all the correct values which are documented in the “Series F4 Temperature Controller Setup Parameters” section of this manual.

### **Security Features**

The Series F4 Controller has several levels of security to prevent unauthorized users from changing critical configuration parameters. Only the Set Point and Profile menus have “Full Access”. TestEquity has configured all other menus to “Password”, and have protected them with a password.

TestEquity does not recommend that these security levels be changed for most applications. However, there will be times when entry into these menus is necessary. For example, you may need to gain access to Setup Page in order to change from °C to °F display, or to change the time or date. You must call TestEquity at 877-512-3457 or 805-480-0638 to obtain the password.

**Temperature Controller Keys and Displays**

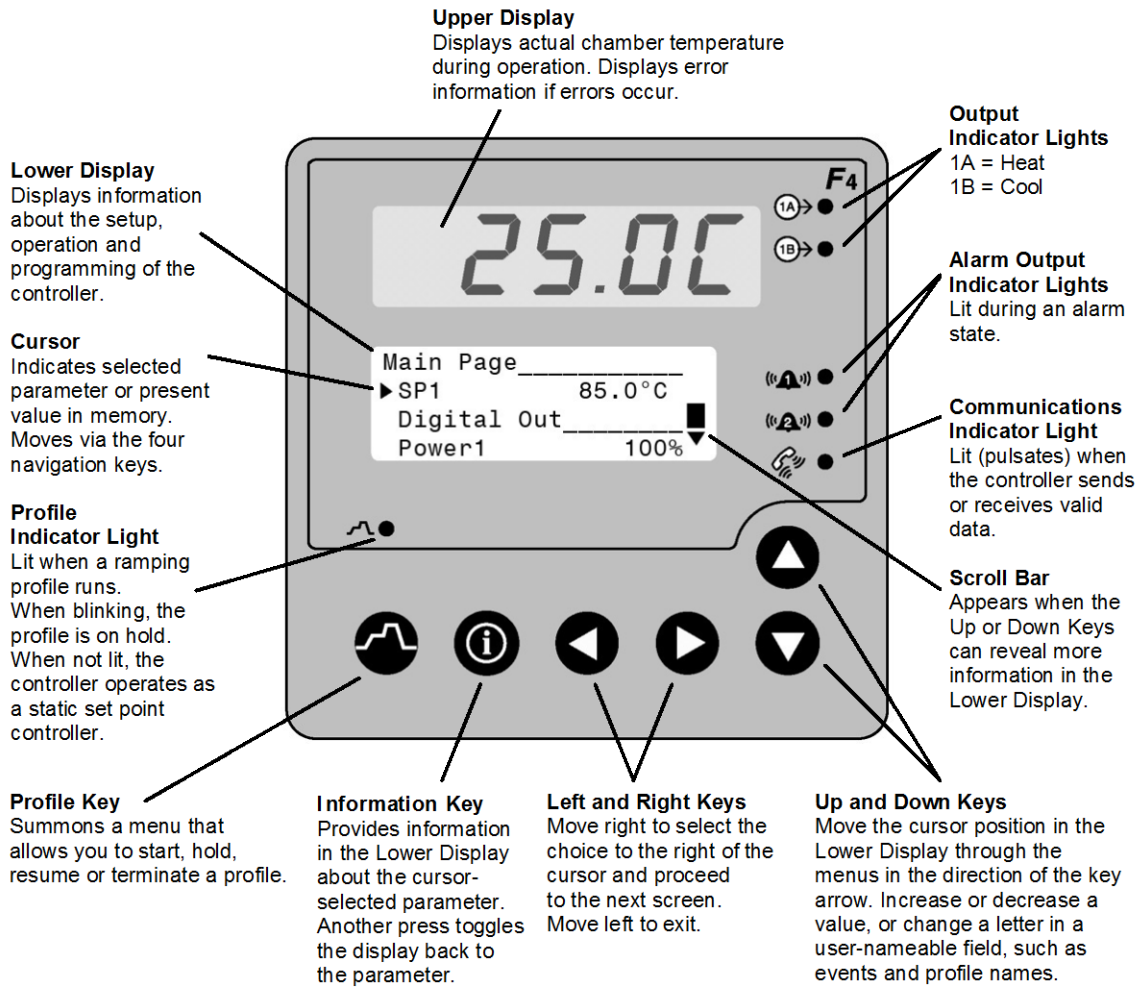

**Figure 4.1 – Temperature Controller Keys and Displays**

To navigate through the menus:

1. Use the ▲ or ▼ key to move the cursor to line up with the item to be selected in a menu on the lower display.
2. Press the ► key to select the item.
3. Enter or change the value, or make a choice with the ▲ or ▼ key.
4. Press the ► key to enter the value or choice.
5. Repeat until you return to the original list.

The ► key again saves the value and proceeds to the next parameter in the series.

The ◀ key saves the value and backs out of the series, and returns to the Main Page.

To edit a parameter, proceed through the series using the ► key without changing values until you find the parameter you want to change. After making the change with the ▲ or ▼ key, you may back using the ◀ key out or proceed using the ► key to the end of the series.

### **Main Page**

---

The Main Page displays manual operating parameters, running program parameters and error messages. It also provides access to the Operations, Profiles, Setup and Factory pages. The following is a list of Main Page parameters and the description of their functions.

#### Main Page

|                  |   |
|------------------|---|
| Current File     | Displayed if running a profile, the name of the profile.                                  |
| Current Step     | Displayed if running a profile, the current step of the profile.                          |
| ▶ SP1            | Static (manual) temperature set point entry. If running a profile, the current set point. |
| Step Type        | Displayed if running a profile, the type of step.   |
| Target SP1       | Displayed if running a profile, the target temperature during a ramp step.                |
| WaitFor Status   | Displayed if running a profile, the status during a WaitFor step.                         |
| Time Remaining   | Displayed if running a profile, the remaining time of the current step.                   |
| DigitalOut       | Status of the event outputs 1 to 8. An “8” indicates when cooling system is ON.           |
| Power1           | The % of throttle of the heat (positive number) or cool (negative number) output.         |
| DigitalIn        | Status of the digital inputs 1 through 4.   |
| Date             | Real-time clock date.   |
| Time             | Real-time clock time.   |
| TESTEQUITY 3007C | Identifies the chamber model number.  |
| Go to Operations | Access to Operations Page   |
| Go to Profiles   | Access to Profiles Page   |
| Go to Setup      | Access to Setup Page. Not displayed if running a profile.                                 |
| Go to Factory    | Access to Factory Page. Not displayed if running a profile.                               |

## System Enable Function

The chamber can be configured to enable or disable all chamber functions through Event 1 (Digital Output 1) in the F4 Controller. The Conditioning Switch needs to be in the Event 1 position. This configuration may be desirable if you want to turn off all chamber function at the end of a programmed profile, or through the communications interface.

All chamber functions will be disabled if Event 1 is Off. If Event 1 is On, all chamber functions will be enabled.

NOTE: The Modbus register to program Digital Output 1 in static set point mode is 2000.

NOTE: In the Profile Create and Edit menus, Digital Output 1 is named **CONDITION**. Remember to set **CONDITION** to **On** in all programmed steps when the chamber is to be operational.

### To Enable or Disable all chamber functions in static set point mode:

1. The F4 Temperature Controller must first be on the Main Page. Press the ▲ or ▼ key to position the Cursor next to the DigitalOut prompt.
2. Press the ► key once. You will see Choose Event Output prompt in the lower display. Press the ▲ or ▼ key to position the Cursor next to Event Output1.
3. Press the ► key once to select Event Output1. Then, press the ▲ or ▼ key to select On or Off.
4. Press the ► key once to return to the Choose Event Output prompt.
5. Press the ◀ key once to return back to the Main Page. You will see a 1 in the DigitalOut line if Event1 is On.

```
Main Page _____
  SP1      85.0°C
► DigitalOut _____
  Power1   50%
```

```
Choose Event Output_
► Event Output1
  Event Output2
  Event Output3
```

```
Event Output1 _____
  Off
► On
```

```
Main Page _____
  SP1      85.0°C
► DigitalOut1 _____
  Power1   50%
```

### Static Set Point Control

The Temperature Controller is in Static Mode when it is not controlling a Profile. When in a Static Mode, the Profile Indicator Light is off (see Fig. 4.1). The Upper Display shows the actual chamber workspace temperature. The Static Set Point (SP1) prompt is accessed from the Main Page.

To enter a Static Set Point:

1. Press the ▲ or ▼ key to position the Cursor next to the SP1 prompt. You may already be at this prompt.
2. Press the ► key once. You will see **Static Set Point1** in the lower display with the current set point indicated below.
3. Press the ▲ or ▼ key to change the temperature set point value.
4. Press the ► key once to enter the new temperature set point. You are now back to the Main Page.

Main Page \_\_\_\_\_  
► SP1 85.0 °C  
DigitalOut \_\_\_\_\_  
Power1 50% ▼

Static Set Point1: \_\_\_\_\_  
85.0 °C  
▲  
▼ Adjusts Value  
◀ Back ► Next

---

### ***Boost Heat***

---

When the demand for heating throttle is at least 50% (Power1 prompt on lower display of F4 Temperature Controller indicates 50% or more), the number 6 will be indicated at the DigitalOut prompt. This will energize the Boost Heating System. Note that the Boost Heaters are only enabled when the compressors are off, but the number 6 may still be indicated.

***LN2 (Liquid Nitrogen) Boost Cooling (Option 0018)***

Liquid Nitrogen can be used to provide faster cooling rates or greater cooling capacity with heavy or energized loads. It does NOT provide infinite cooling capability. For example, with a 25 pound load and a range of +85°C to -40°C, the chamber will cool at 8°C/minute without LN2 and 13°C/minute with LN2. However, it cannot transform the chamber into a “shock chamber”.

The chamber is configured to enable or disable the LN2 Boost Cooling System through Event 2 (Digital Output 2) in the Temperature Controller.

When Event 2 on the Temperature Controller is Off, the LN2 Boost Cooling System is disabled. If Event 2 is On, the LN2 Boost Cooling System is enabled.

**⚠ CAUTION:** Remember to set DigitalOut 2 (Event Output2) to On in static set point mode when the LN2 Boost Cooling System is to be operational. In this mode, the Modbus programming register for Digital Output 2 is 2010.

**⚠ CAUTION:** Remember to set LN2 to On in the profile event prompt for all programmed steps when the LN2 Boost Cooling System is to be operational.

**To Enable or Disable the LN2 Boost Cooling System in static set point mode:**

1. The F4 Temperature Controller must first be on the Main Page. Press the ▲ or ▼ key to position the Cursor next to the DigitalOut prompt.
2. Press the ► key once. You will see Choose Event Output prompt in the lower display. Press the ▲ or ▼ key to position the Cursor next to Event Output2.
3. Press the ► key once to select Event Output2. Then, press the ▲ or ▼ key to select On or Off.
4. Press the ► key once to return to the Choose Event Output prompt.
5. Press the ◀ key once to return back to the Main Page. You will see a 2 in the DigitalOut line if Event1 is On.

```
Main Page _____
SP1          85.0°C
► DigitalOut1 _____
Power1       50%
```

```
Choose Event Output_
Event Output1
► Event Output2
Event Output3
```

```
Event Output2 _____
Off
► On
```

```
Main Page _____
SP1          85.0°C
► DigitalOut12 _____
Power1       50%
```

When the demand for cooling throttle is at least 50% (Power1 prompt on lower display of F4 Temperature Controller indicates -50% or more), the number 7 will be indicated at the DigitalOut prompt. This will energize the LN2 Cooling Solenoid to inject LN2 into the chamber.

### **Profile Programming**

---

The Series F4 Temperature Controller can be programmed to store up to 256 steps into as many as 10 profiles. You do not need a computer to enter a profile – it can be easily done through the controller's front panel keys. A Profile is a set of instructions programmed as a sequence of steps. The controller handles the profile steps automatically, in sequence. As many as 40 different profiles and a total of 256 steps can be stored in non-volatile memory. The 256 steps are grouped by profile. So, one profile could have 256 steps; or 39 profiles could have 6 steps and one could have 22; or 32 profiles could have eight steps each. The maximum number of steps is 256, and the maximum number of profiles is 40.

### **Step Types**

Use the six available step types – Autostart, Ramp Time, Ramp Rate, Soak, Jump and End – to create simple or complex profiles involving all inputs and outputs. The Series F4 prompts you to define each step's properties.

#### **Autostart Step**

The use of an Autostart step in a profile is optional. Autostart pauses a profile until the specified date or day, and time (of a 24-hour-clock). Define the Autostart by choosing:

- Day (of the week) or Date,
- Time

To invoke an Autostart step in a profile, you must activate the profile via the Profile Key and select the Autostart step.

#### **Ramp Time Step**

Ramp Time changes the set point to a new value in a chosen period of time. Define the Ramp Time step by choosing:

- \*Wait for an event or process value
- Event outputs 1 through 5 to turn ON or OFF (For controlling the power to system functions and remote devices.)
- Time (in hours, minutes and seconds)
- Temperature Set Point
- PID set (One of five sets of heat/cool PID parameters. Normally, just leave at PID Set 1.)
- \*\*Guaranteed Soak

#### **Ramp Rate Step**

Ramp Rate changes the set point to a new value in a chosen rate of time. Define the Ramp Rate step by choosing:

- \*Wait for an event or process value
- Event outputs 1 through 5 to turn ON or OFF (For controlling the power to system functions and remote devices.)
- Rate (in degrees per minute)
- Temperature Set Point
- PID set (One of five sets of heat/cool PID parameters. Normally, just leave at PID Set 1.)
- \*\*Guaranteed Soak

### Soak Step

Soak maintains the set point from the previous step for a chosen time in hours, minutes and seconds. Define the Soak step by choosing:

- \*Wait for an event or process value
- Event outputs 1 through 5 to turn ON or OFF (For controlling the power to system functions and remote devices.)
- Time
- PID set (One of five sets of heat/cool PID parameters. Normally, just leave at PID Set 1.)
- \*\*Guaranteed Soak

### Jump Step

Jump initiates another step or profile. Define the Jump step by choosing:

- Profile to jump to;
- Step to jump to; and
- Number of Repeats

**NOTE:** If a power-out condition occurs during a profile and more than 20 jump steps are stored in the F4's Profile Program memory, the controller will terminate the profile and turn off all outputs if Continue, Hold or Terminate was selected as the Power Out action. If Profile Reset or Go to Idle Set Point was selected, the controller will take those actions. A pop-up message will warn of this when the 21st jump step is programmed

### End Step

End terminates the profile in a chosen state. All profiles must have an End step. It cannot be deleted or changed to another step type. Define the End by choosing Hold, Control Off, All Off or Idle end state.

**NOTE:** TestEquity recommends having the end step type to be Hold or Idle. TestEquity does NOT recommend using an end step type of Control Off or All Off. This does not turn off the chamber fan. The chamber temperature can reach +55°C just from heat generated by the fan, and even higher if your test sample is energized.

### \*Wait For step option

The use of Wait For in a profile is optional. Ramp Time, Ramp Rate and Soak steps can be programmed to wait for a particular chamber temperature or event input condition. The wait conditions must be satisfied before the time clock and the step activity proceeds. Digital inputs must first be configured in the System Menu as Wait For Events, with the condition to be met also specified. Then, to wait for this digital input, you must specify On, meaning the condition as configured in the Setup Page, or Off, meaning the opposite of that condition. The digital inputs have been configured to Off by TestEquity, so this option will not show unless reconfigured.

### \*\*Guaranteed Soak step option

The use of Guaranteed Soak in a profile is optional. The Guaranteed Soak step requires the chamber temperature to be at the set point temperature, within the Guaranteed Soak Band value, before the time clock and the step activity proceeds. The Guaranteed Soak Band is configured by TestEquity for 3.0°C, and this can be changed in the System Menu.

## How to Program a New Profile

|  |   |
|--|---|
| <p>1. <b>Go to the Profiles Page.</b><br/>Move the cursor down the Main Page to Go to Profiles, then press the ► key.</p>  | <p>Main Page _____<br/>► Go to Profiles ▲<br/>Go to Setup ■<br/>Go to Factory ▼</p>   |
| <p>2. <b>Create a new Profile.</b><br/>The cursor will be on Create Profile. Press the ► key.</p>  | <p>Main&gt;Profile _____<br/>► Create Profile ■<br/>Edit Profile ▼<br/>Delete Profile ▼</p>   |
| <p>3. <b>Name the profile.</b><br/>You can name your profiles for easy reference if desired. Names can have up to 10 characters. You can also use one of the default profile names (ex. Profile1), and skip this step. To name a profile:</p> <ul style="list-style-type: none"> <li>• Press ► to enter the name space and the first position.</li> <li>• Press the ▲ or ▼ to scroll through the alphabet and stop at the letter or number desired.</li> <li>• Press ► to move to the next position.</li> <li>• Continue until the name is complete, or until you move through the name space into the next screen.</li> <li>• Press ► to save the name of the profile.</li> </ul> | <p>Choose to Name: _____<br/>No<br/>► Yes</p> <p>Enter Profile Name: _<br/><u>PROFILE1</u><br/>▲<br/>▼ Adjusts Char<br/>◀▶ Save Changes</p>   |
| <p>4. <b>Choose the step type.</b><br/>• There are six step types, each of which must be defined through different parameters. (See “Step Types,” earlier in this chapter.)</p>  | <p>Choose Step1 Type: _____<br/>Autostart<br/>► Ramp time ■<br/>Ramp Rate ▼</p>   |
| <p>5. <b>Define each step type.</b><br/>• The Series F4 prompts you to define the parameters of each step type. (See “Step Types,” earlier in this chapter.)</p>   | <p>Choose to wait: _____<br/>► Step does not wait<br/>Step waits for...</p> <p>Enter Ramp Time: _____<br/>00:00:01 (H:M:S)<br/>▲<br/>▼ Adjusts Digit<br/>◀▶ Save Changes</p> <p>Enter Ch1 SP: _____<br/>85.0 °C<br/>▲<br/>▼ Adjusts Value<br/>◀ Back ▶ Next</p> |
| <p>6. <b>Choose the end-state.</b><br/>• All profiles end with an End step, which is preprogrammed into the new profile. (See “End Step,” earlier in this chapter.)</p>  | <p>Choose End State: _____<br/>Control Off ▲<br/>All Off ■<br/>► Idle</p>   |
| <p>7. <b>Save your settings.</b><br/>• Press ◀ to exit the Profiles Page.<br/>• After exiting the Profiles Page, choose ▲ to save profile data.</p>  | <p>Save profile data<br/>or restore values?<br/>▼ Restore ▲ Save</p>  |

## Programming Hints

- The first step in a program should be an initialization step of 1-second, usually at a set point of +23°C.
- The next to last step establishes a condition to end on. For example, you may want to end the program by holding at +23°C, so this step would be to go to +23°C.
- The final step of every profile is End. You cannot delete an End step or change it to another type, but you can insert new steps before it.
- TestEquity recommends having the end step type to be Hold or Idle.
- TestEquity does NOT recommend using an end step type of All Off or Control Off. This does not turn off the chamber fan. The chamber temperature can reach +55°C just from heat generated by the fan, and even higher if your test sample is energized. See Protecting an Energized Test Sample in Chapter 5 for important information regarding energized test samples.

## Profile Key

The  Profile key:

- Initiates the profile mode;
- Initiates the Hold-profile state;
- Initiates the Resume-profile command;
- Initiates the Terminate-profile command.

The Profile Key functions only from the Main Page.

## How to Start a Profile

To initiate the profile mode, press the  Profile key and answer the questions that follow.

|  |   |
|--|---|
| <p>1. <b>Press the Profile key to enter the Profile Control menu.</b></p> <ul style="list-style-type: none"> <li>• The Profile Indicator will begin blinking.</li> <li>• Press the ▲ key for Yes.</li> </ul>   | <p>Start a Profile?</p> <p style="text-align: center;">▼ No    ▲ Yes</p>  |
| <p>2. <b>Select the desired stored profile.</b></p> <ul style="list-style-type: none"> <li>• Press the ▲ or ▼ to scroll through the list of stored profiles.</li> <li>• Press ► to select the desired profile.</li> </ul>  | <p>Start Profile: _____</p> <p style="padding-left: 20px;">Profile1</p> <p style="padding-left: 20px;">► Profile2    ▼</p> <p style="padding-left: 20px;">Profile3</p>  |
| <p>3. <b>Select the desired step to start on.</b></p> <ul style="list-style-type: none"> <li>• Press the ▲ or ▼ to scroll through the list of steps. Generally you would start on Step 1, but you can also start on any other step.</li> <li>• Press ► to select the desired start step and the profile will begin to run. The Profile Indicator will stay lit.</li> </ul> | <p>Start: _____</p> <p style="padding-left: 20px;">► Step 1 Ramp Time</p> <p style="padding-left: 20px;">Step 2 Soak    ▼</p> <p style="padding-left: 20px;">Step 3 Ramp Time</p><br><p>Main Page _____</p> <p style="padding-left: 20px;">► Profile 2 Running</p> <p style="padding-left: 20px;">Step 1    ▼</p> <p style="padding-left: 20px;">SP1            85.0°C    ▼</p> |

While running a profile, the Main Page on the lower display will keep you informed about the progress of the profile. Use the ▲ or ▼ key to scroll through the list of running profile parameters. You cannot manually change any operating condition while the profile is running.

## How to Hold/Resume a Running Profile

|   |   |
|---|---|
| <p>1. <b>To Hold a running profile, press the Profile key to enter the Profile Control menu.</b></p> <ul style="list-style-type: none"> <li>• Then press ▲ or ▼ to make your choice for Hold.</li> <li>• Press ► to select Hold.</li> <li>• The Main Page will appear with a profile status of Holding. The Profile Indicator will be off.</li> </ul> | <pre> Hold Profile: _____   Don't Hold   ► Hold   Terminate  Main Page _____   ► Profile 2  Holding     Step          2     SP1           23.0°C     </pre> |
| <p>2. <b>To Resume profile on hold, press the Profile key to enter the Resume Profile menu.</b></p> <ul style="list-style-type: none"> <li>• Then press ▲ or ▼ to make your choice for Resume.</li> <li>• Press ► to select Resume.</li> </ul>  | <pre> Resume Profile: _____   Continue Holding   ► Resume   Terminate     </pre>  |

While a profile is on Hold, the current set point can be adjusted at the SP1 prompt on the Main Page. When a profile is resumed during a Ramp step, the controller uses the Static Set Point from the Main Page to calculate the rate of change needed to get to the set point at the end of the step. When a profile is resumed in a soak step, the new set point value will be used as the soak value for the time remaining in the step.

## How to Terminate a Running/Holding Profile

|  |  |
|--|--|
| <p>1. <b>Press the Profile key while the profile is running to enter the Resume Control menu.</b></p> <ul style="list-style-type: none"> <li>• Then press ▲ or ▼ to make your choice for Terminate.</li> <li>• Press ► to select Terminate.</li> </ul> | <pre> Hold Profile: _____   Don't Hold   Hold   ► Terminate     </pre> |
|--|--|

If you manually terminate a running profile, the profile ends with a set point of Off. This does not turn off the chamber fan. The chamber temperature can reach +55°C just from heat generated by the fan, and even higher if your test sample is energized. See Protecting an Energized Test Sample in Chapter 5 for important information regarding energized test samples.

## How to Delete or Re-Name a Profile

|   |  |
|---|--|
| <p>1. <b>Go to the Profiles Page.</b><br/>Move the cursor down the Main Page to Go to Profiles, then press the ► key.</p>   | <pre> Main Page _____   ► Go to Profiles   Go to Setup   Go to Factory     </pre>          |
| <p>2. <b>Choose Delete or Re-Name.</b></p> <ul style="list-style-type: none"> <li>• Press ▲ or ▼ to scroll through your choice.</li> <li>• Press ► to select your choice.</li> <li>• The controller will prompt you to select the profile you want to delete or re-name.</li> </ul> | <pre> Main&gt;Profile _____   Edit Profile   ► Delete Profile   Re-Name Profile     </pre> |

## How to Edit a Profile

|  |   |
|--|---|
| <p>1. <b>Go to the Profiles Page.</b><br/>Move the cursor down the Main Page to Go to Profiles, then press the ► key.</p>  | <p>Main Page _____<br/>► Go to Profiles<br/>Go to Setup<br/>Go to Factory</p>           |
| <p>2. <b>Choose Edit Profile.</b><br/>• Press the ▼ key to choose on Edit Profile.<br/>• Then press the ► key.</p>   | <p>Main&gt;Profile _____<br/>Create Profile<br/>► Edit Profile<br/>Delete Profile</p>   |
| <p>3. <b>Select the desired stored profile to edit.</b><br/>• Press the ▲ or ▼ to scroll through the list of stored profiles.<br/>• Press ► to select the desired profile.</p>   | <p>...Edit Profile: _____<br/>Profile1<br/>► Profile2<br/>Profile3</p>                  |
| <p>4. <b>Choose how to edit the step.</b><br/>• Press the ▲ or ▼ to scroll through the list of step edit choices.<br/>• Press ► to select your choice.</p>   | <p>Choose to: _____<br/>Insert Step<br/>► Edit Step<br/>Delete Step<br/>Done</p>        |
| <p>5. <b>To edit a step.</b><br/>• Press the ▲ or ▼ to scroll through the list of steps you want to edit.<br/>• Press ► to scroll through the step parameters and make any desired changes.</p>  | <p>Edit Step: _____<br/>► Step 1 Ramp Time<br/>Step 2 Soak<br/>Step 3 Ramp Time</p>     |
| <p>6. <b>To insert a step.</b><br/>• Choose Edit Profile (see step 4 above)<br/>• Press the ▲ or ▼ to scroll through the number of the step that the new step will precede.<br/>• Press ► to enter the new step and follow the step parameter prompts.</p> | <p>Insert Before: _____<br/>Step 1 Ramp Time<br/>► Step 2 Soak<br/>Step 3 Ramp Time</p> |
| <p>7. <b>To delete a step.</b><br/>• Choose Delete Step (see step 4 above)<br/>• Press the ▲ or ▼ to scroll through the number of the step you want to delete.<br/>• Press ► to delete the step.</p>   | <p>Delete Step: _____<br/>Step 1 Ramp Time<br/>► Step 2 Soak<br/>Step 3 Ramp Time</p>   |
| <p>8. <b>Save your settings.</b><br/>• Press ◀ successively to exit the Profiles Page.<br/>• After exiting the Profiles Page, choose ▲ to save the new profile values, or ▼ to restore the old values.</p>   | <p>Save profile data<br/>or restore values?<br/>▼ Restore ▲ Save</p>                    |

- Inserting or deleting a step will renumber all steps that follow.
- A Jump Step that jumps to an End Step cannot be deleted.
- An End Step cannot be deleted.
- Inserting a new ramp step usually requires inserting an associated soak step.
- Deleting a ramp step usually requires deleting the associated soak step.

## Profile Example

+85°C to -40°C, 5°C/minute ramp, 1 hour soak time, 100 cycles. End with return to +23°C manual set point. Turn chamber off at end of profile. The Conditioning switch must be in the Event 1 position if you want the profile to turn the chamber ON/OFF.

| Step Number | Step Type | Date Day, Time | Wait for | COND | LN2 | 3 | 4 | 5 | 6 | 7 | Time H:M:S | Rate | Chl SP | PID Set | Guar. Soak | Jump to Profile | Step | Repeats | End Type | Idle SP   |
|-------------|-----------|----------------|----------|------|-----|---|---|---|---|---|------------|------|--------|---------|------------|-----------------|------|---------|----------|-----------|
| 1           | Ramp Time | —              | >        | On   | >   | > | > | > | > | > | 00:00:01   | —    | 23.0   | 1       | No         | —               | —    | —       | —        | —         |
| 2           | Ramp Rate | —              | >        | On   | >   | > | > | > | > | > | —          | 5.0  | 85.0   | 1       | No         | —               | —    | —       | —        | —         |
| 3           | Soak      | —              | >        | On   | >   | > | > | > | > | > | 01:00:00   | —    | —      | 1       | No         | —               | —    | —       | —        | —         |
| 4           | Ramp Rate | —              | >        | On   | >   | > | > | > | > | > | —          | 5.0  | -400.0 | 1       | No         | —               | —    | —       | —        | —         |
| 5           | Soak      | —              | >        | On   | >   | > | > | > | > | > | 01:00:00   | —    | —      | 1       | No         | —               | —    | —       | —        | —         |
| 6           | Jump      | —              | >        | >    | >   | > | > | > | > | > | —          | —    | —      | —       | —          | Name            | 2    | 99      | —        | —         |
| 7           | Ramp Rate | —              | >        | On   | >   | > | > | > | > | > | —          | 5.0  | 23.0   | 1       | No         | —               | —    | —       | —        | —         |
| 8           | Soak      | —              | >        | Off  | >   | > | > | > | > | > | 00:00:01   | —    | —      | 1       | No         | —               | —    | —       | —        | —         |
| 9           | End       | —              | —        | —    | —   | — | — | — | — | — | —          | —    | —      | —       | —          | —               | —    | —       | —        | Idle 23.0 |

**Step Description**

- Establishes a recommended initialization step. Goes to +23°C as quickly as possible. Chamber is turned ON via Event 1 (named CONDITION).
- Goes to +85°C at a controlled rate of 5°C per minute. Chamber is turned ON via Event 1 (named CONDITION).
- Will hold for 1 hour. Chamber remains ON via Event 1.
- Goes to -40°C at a controlled rate of 5°C per minute. Chamber is turned ON via Event 1 (named CONDITION).
- Will hold for 1 hour. Test sample remains ON via Event 1.
- Jumps back to step 2. Repeats this 99-times, for a total of 100-cycles.
- After all cycles are completed, goes to +23°C at a controlled rate of 5°C per minute. Chamber is turned ON via Event 1 (named CONDITION).
- Chamber is turned OFF via Event 1 (named CONDITION).
- End of program. Controller returns to a +23°C manual set point. Chamber remains OFF via Event 1 (named CONDITION).

### ***Digital Event Outputs***

---

The Temperature Controller has digital outputs which can be configured as Event Outputs to turn remote devices on and off. There are three Event Outputs which are available for customer use. The remaining events are used for chamber system functions. The Event Outputs are accessed from the Temperature Controller Main Page.

| <b>Event</b> | <b>Function</b>   |
|--------------|---|
| Event 1      | System Enable (CONDITION). (Works when Conditioning Switch is in the Event 1 position.) |
| Event 2      | LN2 Boost Enable (LN2). Must be ON to enable the optional LN2 system.                   |
| Event 3      | Available for customer use  |
| Event 4      | Available for customer use  |
| Event 5      | Available for customer use  |
| Event 6      | Boost Heat function (indicator only)  |
| Event 7      | Boost Cool function (indicator only)  |
| Event 8      | Compressor Enable (indicator only)  |

To control Event Outputs 1 through 5:

1. Press the ▲ or ▼ key to position the Cursor next to the DigitalOut prompt.
2. Press the ► key once. You will see Choose Event Output prompt in the lower display.
3. Press the ▲ or ▼ key to position the Cursor next to the EventOutput prompt which you want to change. You will be able to select from EventOutput1 through EventOutput5.
4. Press the ► key once to select the desired EventOutput. Then, press the ▲ or ▼ key to select On or Off.
5. Press the ► key once to return to the Choose Event Output prompt.
6. Press the ◀ key once to return back to the Main Page.

### **Event Relays**

There are three solid state relays available to control AC operated devices, such as power to a test sample. The solid state relays are rated for 24 to 240 VAC, 5.0 Amps.

#### **Connecting to the Event Relays**

1. Turn the Main Disconnect switch to the OFF position.
2. Remove the lower door retaining screw located on the right side. Open the lower door.
3. The Event Relays are located on the lower right side of the electrical subpanel.
4. The event outputs are just switches. You must provide power from an external source.
5. A 1/2-inch conduit hole is provided on the left side of the lower door to route your wires through. Use the appropriate wire/cable management fittings.

### ***Operations Page***

---

The Operations Page provides access to menus for control tuning (PID) and controller alarms. TestEquity has configured the security to require a password for access to all parameters in the Operations Page. You must call TestEquity at 877-512-3457 or 805-480-0638 to obtain the password.

**⚠ CAUTION:** The Series F4 Temperature Controller “Alarm” functions are NOT used in the chamber’s safety system and are NOT connected. TestEquity does NOT recommend using the Series F4 alarm function as the main protection device. The independent EZ-Zone Limit Controller functions as the main protection device.

**⚠ CAUTION:** The Series F4 Temperature Controller PID values have been properly configured by TestEquity to match the chamber’s system requirements and to perform optimally over a wide range of operating conditions. Improper modifications to these values can result in erratic performance and unreliable operation. Do not attempt to modify the PID values, unless you thoroughly understand what you are doing. Setup examples in the “Series F4 User’s Manual” are NOT applicable to this chamber. If there is any doubt, please call TestEquity before proceeding. The correct values are documented in the “Series F4 Temperature Controller Setup Parameters” section of this manual.

**⚠ CAUTION:** The Autotune PID function is not appropriate for use in this chamber. Using this function will result in tuning values that will not work correctly.

### ***Setup Page***

---

The Setup Page provides access to menus for configuring the controller hardware. TestEquity has configured the security to require a password for access to the Setup Page. However, there will be times when entry into these menus is necessary. For example, you may need to gain access to Setup Page in order to change from °C to °F display, or to change the time or date. You must call TestEquity at 877-512-3457 or 805-480-0638 to obtain the password.

**⚠ CAUTION:** The Series F4 Temperature Controller setup values have been properly configured by TestEquity to match the chamber’s system requirements and to perform optimally over a wide range of operating conditions. Improper modifications to these values can result in erratic performance and unreliable operation. Do not attempt to modify the setup values, unless you thoroughly understand what you are doing. Setup examples in the “Series F4 User’s Manual” are NOT applicable to this chamber. If there is any doubt, please call TestEquity before proceeding. The correct values are documented in the “Series F4 Temperature Controller Setup Parameters” section of this manual.

### ***Factory Page***

---

The Factory Page provides access to menus for controller diagnostics and calibration. TestEquity has configured the security to require a password for access to the Setup Page. However, there will be times when entry into these menus is necessary. For example, you may need to gain access to Factory Page in order to perform a calibration, or to change the security password. You must call TestEquity at 877-512-3457 or 805-480-0638 to obtain the password.

**⚠ CAUTION:** NEVER select “Full Defaults” in the Factory/Test Menu. This will erase all the correct values which are documented in the “Series F4 Temperature Controller Setup Parameters” section of this manual.

### **Computer Interface**

---

**△ CAUTION:** Every setting in the F4 Controller can be accessed via the computer interface. Improper modifications to configuration settings can result in erratic performance and unreliable operation. Setup examples in the “Series F4 User’s Manual” are NOT applicable to this chamber. The correct values are documented in the “Series F4 Temperature Controller Setup Parameters” section of this manual.

### **RS-232C**

The F4 Temperature Controller has an RS-232C interface. A DB-9 connector is located on the rear panel. It is wired to accommodate a null-modem cable. On chambers with internal GPIB interface, model TE-0003, RS-232C is not available.

To communicate with the controller from a PC, you need to run software that uses the Modbus RTU protocol. Each controller function has a “register” number which can be read or written to (when applicable). These registers are listed Chapter Seven of the “Series F4 User’s Manual”. RS-232C Modbus programming resources and LabVIEW drivers can be downloaded from <http://www.testequity.com/static/11/> .

### **Common Modbus Registers**

- The actual chamber temperature reading is Modbus register 100 (Input 1 Value).
- The static temperature set point is Modbus register 300 (Set Point 1).
- The temperature set point during a profile is Modbus register 4122 (Set Point 1, Current Profile Status).
- Event 1 (to turn the chamber ON/OFF) is Modbus register 2000.
- Event 2 (to enable LN2) is Modbus register 2010.
- The decimal points are implied. For example, 1005 is actually 100.5 and –230 is –23.0.

### **GPIB (optional)**

The optional GPIB interface, model TE-0003, consists of an internal board which converts the F4 controller’s serial interface to GPIB. Chambers with a TE-0003 GPIB interface have a GPIB connector in place of the RS-232C connector. Alternatively, the external GPIB interface, model TE-1052, consists of an external converter box that connects to the chamber’s RS-232C interface.

GPIB programming resources and LabVIEW drivers can be downloaded <http://www.testequity.com/static/10/> .

### **Ethernet (optional)**

The optional Ethernet interface, model TE-1055, consists of an external converter box that connects to the chamber’s RS-232C interface.



## Chapter 5 - Limit Controller

### *Introduction*

---

The EZ-Zone Limit Controller is a protection device. It turns the chamber OFF if the workspace temperature exceeds either a high temperature or low temperature limit. You can set these limits to correspond to the maximum and minimum temperature that your test sample can safely withstand. This provides protection against someone setting the F4 Controller to a temperature that is unsafe for the test sample. It also provides protection in the unlikely event of a chamber system component failure. The Limit Controller has its own temperature sensor (thermocouple) and functions completely independent of the F4 Controller.

This section provides a brief overview on how to operate the Limit Controller. For more detailed instructions, see the “EZ-Zone User’s Manual”.

**⚠ CAUTION:** The “EZ-Zone User’s Manual” is a general manual and is written by the manufacturer, Watlow, for a wide variety of applications and configurations. Not all features or functions are applicable. Only the capabilities of a model PM6L1AJ-AAAABAA are applicable.

**⚠ CAUTION:** The EZ-Zone Limit Controller has been properly configured by TestEquity to match the chamber’s system requirements. Improper modifications to these setup values can result in unreliable and unsafe operation. Do not attempt to modify the setup values, unless you thoroughly understand what you are doing. The correct values are documented in the “EZ-Zone Limit Controller Setup Parameters” section of this manual.

**⚠ CAUTION:** Always verify that the Limit Controller’s high and low limits are set to temperatures that are appropriate for your test sample.

**⚠ CAUTION:** If your test sample is energized, it may be capable of raising the workspace temperature beyond safe limits. This could occur if your test sample exceeds the live load rating of the chamber or if the chamber’s refrigeration system fails. This chamber has a set of contacts that can be used to remove power to your test sample if the Limit Controller’s temperature limits are exceeded.

## Limit Controller Keys and Displays

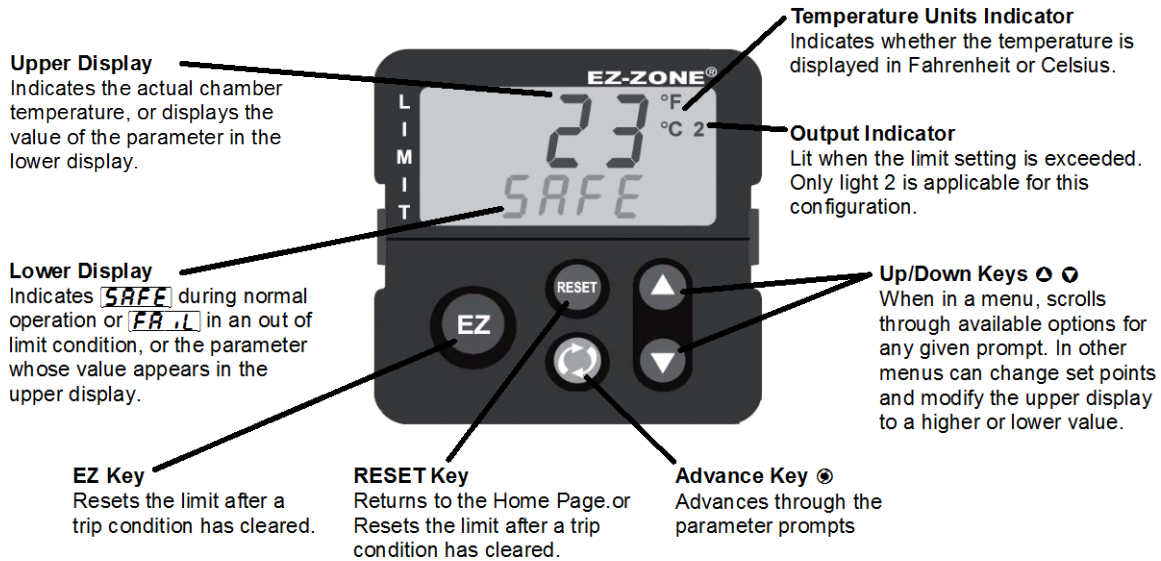

Figure 5.1 – Limit Controller Keys and Displays

### How to Set the High and Low Temperature Safety Limits

1. Press the ⊙ key once to get the **LL5** prompt in the lower display. This is the Low Limit Set Point prompt.
2. Press the ▲ or ▼ key to enter the desired Low Limit Set Point in the upper display. Make sure it is lower than your actual chamber temperature set point, and at least below room temperature to prevent nuisance tripping.
3. Press the ⊙ key once again to get the **Lh5** prompt in the lower display. This is the High Limit Set Point prompt.
4. Press the ▲ or ▼ key to enter the desired High Limit Set Point in the upper display. Make sure it is higher than your actual chamber temperature set point to prevent nuisance tripping.
5. Press the RESET Key to return to the Home Page.
6. The upper display will show the actual chamber temperature while the lower display will show **SAFE** as long as the limits are not exceeded.

### Resetting an Out of Limit Condition

If the limit is exceeded, the Limit Controller will flash **L h I** (high limit) or **L l I** (low limit) in the upper display and **ALLO** in the lower display, alternating with the actual chamber temperature in the upper display and **FAIL** in the lower display. It will also shut down all chamber functions. The Limit Controller cannot be reset until the temperature returns to within the limit set points. Then, you must press the RESET or EZ Key to resume normal operation.

### Silencing the Audible Alarm

Turning off the Conditioning switch on the chamber front panel lets you temporarily turn off the Audible Alarm, even though the High or Low Limit condition may still exist.

## Protecting an Energized Test Sample

If your test sample is energized, it may be capable of raising the workspace temperature beyond safe limits. This could occur if your test sample exceeds the live load rating of the chamber or if the chamber’s refrigeration system fails.

This chamber has a set of safety contacts that can be used to remove power to your test sample if the Limit Controller’s temperature limits are exceeded.

The safety contacts are rated as follows:

Resistive: 10 A, 250 VAC or 10 A, 28 VDC

Inductive: 7 A, 250 VAC

To access the safety contacts:

1. Turn the Main Disconnect Switch to the OFF position.
2. Remove the lower door retaining screw located on the right side. Open the lower door.
3. Locate the Terminal Strip on the electrical sub panel. Connections to the safety contacts are at terminals A1 and A2.

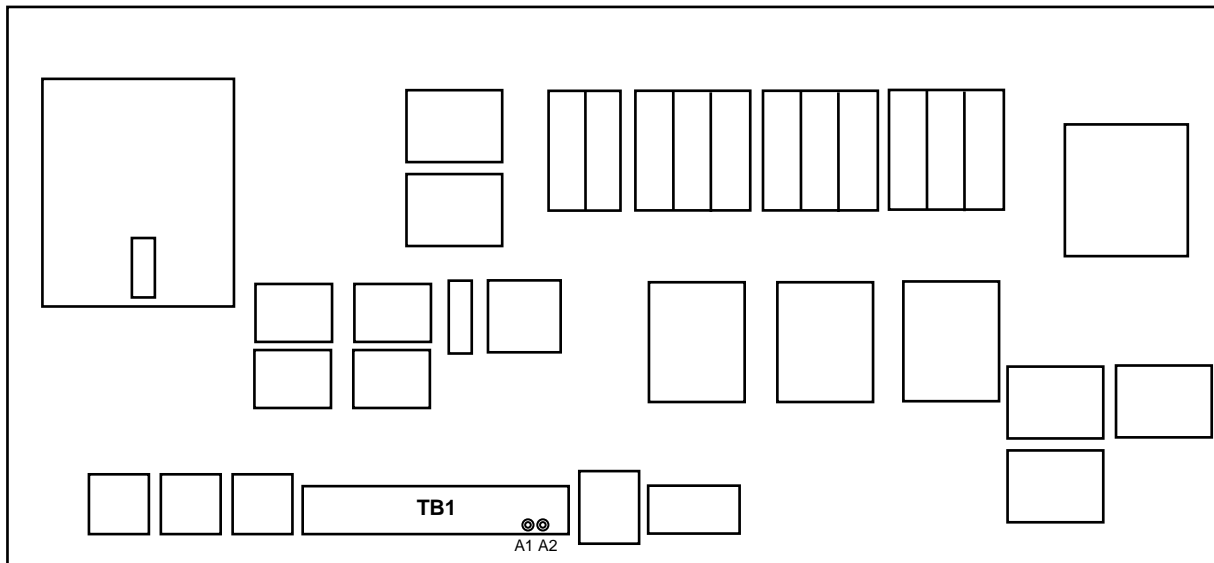

Figure 5-2 – Location of Safety Contact Connections on the Electrical Sub Panel



### Chapter 6 – Frequently Asked Questions

#### **The input voltage label says 230 (or 208) VAC. I thought I had 220 (or 240) VAC. Is that ok?**

220 V is a misnomer—there is no such standard as nominal 220 V in the United States. The standard line voltage in the United States is either 208 V or 240 V. You must verify the exact type of electrical service you have. If there is any doubt, you must consult with a qualified electrician who is familiar with industrial plant wiring. In addition, the input line voltage should be measured while the chamber is operating in a continuous HEAT mode to ensure that the expected nominal voltage of either 208 V  $-5/+10\%$  or 230 V  $\pm 10\%$  is present. Also, make sure the chamber is properly configured for either 208 V or 240 V nominal input as described in Chapter 2 - Input Power Configuration. If you have a 208 V line that measures under 198 V, the chamber will require boost transformers. If you have a 240 V line that measures over 252 V (a 240 V line which is 10% high could measure up to 264 V), the chamber will require bucking transformers.

#### **Why doesn't the chamber come with a power cord and plug?**

Most local electrical codes require permanent wiring for this type of equipment. If used as a portable device, a flexible wire with a plug may be acceptable, but local codes may limit the length to 6 feet. TestEquity recommends that the appropriate method for your installation be determined by a qualified electrician who is familiar with industrial plant wiring.

#### **I need to send the chamber outside North America. Will it work with their power?**

Outside North America, most countries have 50 Hz. Standard three phase voltage systems in most 50 Hz countries are typically 380 V or 400 V. Please call TestEquity for details on voltage reducing transformers for 50 Hz operation. Note that the cooling performance will be reduced by 17% at 50 Hz.

#### **Why does my chamber heat or cool slower than the published specifications?**

Performance is significantly affected by the characteristics of your test sample. Factors include size, weight, material, shape, and power dissipation if energized. The test sample should be placed in the chamber in a manner that allows for air circulation. You should not place the test sample directly on the chamber floor. It should be placed on the shelf. Multiple test samples should be distributed throughout the chamber to ensure even airflow and minimize temperature gradients. If necessary, additional shelves should be used to evenly distribute the load. You can determine if the chamber is operating properly by following the procedure in “How to verify the chamber performance”.

#### **How can I modify the chamber to cool faster?**

Liquid Nitrogen (LN2) can be used to provide faster cooling rates or greater cooling capacity with heavy or energized loads. It does NOT provide infinite cooling capability. For example, with a 25 pound load and a range of  $+85^{\circ}\text{C}$  to  $-40^{\circ}\text{C}$ , the chamber will cool at  $8^{\circ}\text{C}/\text{minute}$  without LN2 and  $13^{\circ}\text{C}/\text{minute}$  with LN2. However, it cannot transform the chamber into a “shock chamber”. If this chamber was not ordered with LN2 Boost Cooling, then you can retrofit the chamber by ordering Option 0018.

You CANNOT use CO2 (Liquid Carbon Dioxide) in this system and we do not sell a CO2 Boost System due to potential reliability issues associated with the unintended formation of dry ice.

### **Why is there water/ice/snow in the chamber?**

Any time the ambient air is subjected to temperatures below the dew point, moisture will condense out of the air. The effect is ice or frost during low temperature operation. When the chamber is heated above 0°C, the ice or frost will turn into water. To avoid moisture condensation, make sure the port plugs are inserted at all times. Also, avoid opening the chamber door while the chamber is operating at temperatures below room ambient. When a low temperature test is completed, warm the chamber to at least room ambient before opening the chamber door and before removing your test sample.

### **My test specification requires convection heat only. Can I turn the circulator motor off?**

NO! This will damage the heating and refrigeration systems and void the warranty. You need a “gravity convection oven” for that kind of test.

### **How accurate is the chamber?**

That’s a loaded question! There is no “chamber accuracy” specification as such. The answer requires an understanding of several performance parameters.

Control Tolerance – The Temperature Controller uses a thermocouple control sensor, which is located in the discharge airflow. Control tolerance is a measure of how much the temperature varies after stabilization at the control sensor. It is a measure of the relative variations, NOT the absolute accuracy of the readout. The control tolerance specification for this chamber is  $\pm 0.5^{\circ}\text{C}$ , or a total of  $1^{\circ}\text{C}$ . For example, the temperature set point may be  $-25.0^{\circ}\text{C}$ . The actual temperature varies between  $-25.4^{\circ}\text{C}$  and  $-24.5^{\circ}\text{C}$ . This corresponds to  $-0.4^{\circ}\text{C}$  and  $+0.5^{\circ}\text{C}$  or a total of  $0.9^{\circ}\text{C}$  of RELATIVE variations. These specifications are for an empty chamber. The addition of a test sample may effect the control variations. In some instances, the test sample will reduce these variations.

Uniformity – Also known as Gradients. This is a measure of variations in temperature at different locations throughout the chamber interior, at the same time, after stabilization. The uniformity specification for this chamber is  $\pm 1.0^{\circ}\text{C}$  or a total of  $2^{\circ}\text{C}$ , when measured at least 2" away from the chamber interior walls. These specifications are for an empty chamber. The addition of a test sample may affect the temperature uniformity. For example, an energized test sample will produce a higher temperature near the sample.

Controller Accuracy – This is the ability of the temperature controller to accurately display a temperature measurement when compared to a standard. The controller display accuracy is  $\pm 1.66^{\circ}\text{C}$ . However, the total measurement accuracy in the chamber includes the thermocouple sensor wire accuracy. Thermocouple wire accuracy is  $\pm 1^{\circ}\text{C}$  or 0.75% of reading, whichever is greater. Therefore, total system accuracy over the chamber’s operating range can be as much as  $\pm 2.66^{\circ}\text{C}$ , although the typical accuracy is often better than  $\pm 1.0^{\circ}\text{C}$ .

### **Can I tilt the chamber to move it?**

You should be able to tilt the chamber 45 degrees to move it. After tilting it and moving it into place, perform the steps as outlined in “How to inspect the refrigeration machinery compartment” and “How to check the refrigerant charge” before placing the chamber back into service to make sure that no damage has occurred.

**I'm not going to use the chamber for a while. Is there anything I should do to prepare it for storage?**

Perform ALL the steps in the Preventive Maintenance Schedule before placing the chamber into storage. This will ensure that the chamber will be ready to operate when it is taken out of storage. If the chamber has a problem and is still under warranty, these problems should be resolved before being placed into storage, since the warranty period starts from the date of shipment. The chamber should be stored in a conditioned environment. Do not store it outside or where it will be subjected to dirt or excessive moisture.

**I haven't used the chamber for a while. Is there anything I should do to prepare it for operation?**

Perform ALL the steps in the Preventive Maintenance Schedule before placing the chamber back into service. This will ensure that nothing has been damaged and that a leak has not developed.

This chamber has a crankcase heater to protect the high-stage compressor. The chamber must be connected to the power source AND the Main Disconnect Switch must be ON for 3 hours prior to operating the chamber. Although it may be safe to use the chamber immediately, this procedure ensures the longest possible life for the high-stage compressor if the chamber has been removed from the power source for more than 24 hours.

**Can the person who services our air conditioning also service the chamber?**

Probably not. Most air conditioning mechanics are not familiar with low-temperature cascade refrigeration systems. While this chamber is relatively easy to maintain and repair, most air conditioning mechanics do not have the necessary refrigerants and may not be familiar with the microprocessor-based controls. This chamber should only be serviced by a qualified mechanic that is familiar with low-temperature cascade refrigeration systems. Call TestEquity to recommend one in your area, or to check if the one you would like to use is qualified.

**Can/Should I put a filter in front of the condenser air inlet?**

No, TestEquity does not recommend this. Just follow the maintenance procedures and clean the condenser fins periodically.

**How often should I charge the refrigeration system?**

This chamber uses a closed-loop refrigeration system. Just like your refrigerator at home, it does not need periodic charging. If the charge is low, this means that there is a leak. Leaks should be repaired before recharging.

**What kind of Freon does the chamber use?**

The word Freon<sup>®</sup> is a DuPont registered trade name for their CFC-based refrigerants and is incorrectly used as a generic term for refrigerants. TestEquity chambers do not use CFC-based refrigerants. The high-stage system uses R-404A, which is also known as DuPont Suva<sup>®</sup> HP62. The low-stage system uses R-508B, which is also known as DuPont Suva<sup>®</sup> 95.



## Chapter 7 – Specifications

### ***Model 3007C Chamber Specifications***

---

|                          |  |  |  |  |  |  |
|--------------------------|--|--|--|--|--|--|
| <b>Temperature Range</b> | -73°C to +175°C  |  |  |  |  |  |
| <b>Control Tolerance</b> | ±0.5°C (Measured at the control sensor after stabilization)    |  |  |  |  |  |
| <b>Uniformity</b>        | ±1.0°C (Variations throughout the chamber after stabilization) |  |  |  |  |  |

|                             |              |            |              |              |              |              |
|-----------------------------|--------------|------------|--------------|--------------|--------------|--------------|
| <b>Live Load Capacity @</b> | <b>+23°C</b> | <b>0°C</b> | <b>-20°C</b> | <b>-40°C</b> | <b>-55°C</b> | <b>-65°C</b> |
|                             | 3700 W       | 3500 W     | 3300 W       | 2700 W       | 2300 W       | 1800 W       |

**Cooling Rate, Compressors Only (empty chamber)\***

|                        |              |                 |              |              |              |              |
|------------------------|--------------|-----------------|--------------|--------------|--------------|--------------|
|                        |              | <b>End Temp</b> |              |              |              |              |
| <b>Start Temp to →</b> | <b>+23°C</b> | <b>0°C</b>      | <b>-40°C</b> | <b>-55°C</b> | <b>-65°C</b> | <b>-73°C</b> |
| <b>+85°C</b>           | 18°C/min     | 14°C/min        | 12°C/min     | 11°C/min     | 10°C/min     | Ultimate     |

**Cooling Rate, Compressors Only (25 lb static aluminum load)\***

|                        |              |                 |              |              |              |              |
|------------------------|--------------|-----------------|--------------|--------------|--------------|--------------|
|                        |              | <b>End Temp</b> |              |              |              |              |
| <b>Start Temp to →</b> | <b>+23°C</b> | <b>0°C</b>      | <b>-40°C</b> | <b>-55°C</b> | <b>-65°C</b> | <b>-73°C</b> |
| <b>+85°C</b>           | 14°C/min     | 10°C/min        | 8°C/min      | 7°C/min      | 6°C/min      | Ultimate     |

**Cooling Rate, LN2 Boost and Compressors (empty chamber)\***

20°C/minute from +85°C to -40°C

**Cooling Rate, LN2 Boost and Compressors (25 lb static aluminum load)\***

13°C/minute from +85°C to -40°C

**Heat Up Ramp Rate (empty chamber)\***

17°C/minute from -40°C to +85 °C

**Heat Up Ramp Rate (25 lb static aluminum load)\***

12°C/minute from -40°C to +85 °C

\* **NOTE:** Ramp rates are measured at the control sensor after a 2 hour soak at the respective start temperature with an empty chamber. Measured with setpoint set beyond the start and end temperatures. Ramp rates do not include the effect of proportional band when approaching setpoint.

**Input Power Requirements**

**230 V ±10%, 60 Hz, 3 PH**      Max Current Draw 39 A; Recommended Service 50 A

**208 V -5/+10%, 60 Hz, 3 PH**      Max Current Draw 35 A; Recommended Service 45 A

Input may be configured for nominal 208 V or 230 V in the field by changing jumpers.

Call for other voltages or 50 Hz operation.

**Workspace Dimensions**      24" W x 21" H x 24" D (7 cubic feet)

**Outside Dimensions**      33" W x 79" H x 54.25" D (nominal)

Door latch adds 3" to width on right side, may be removed for move-in.

**Min. Installed Clearance**      12" from the left and right side, 24" from the rear

**Access Ports**      4" Port on left and right side (two total), Supplied with foam plugs

**Weight**      1,200 pounds

**Heat of Rejection**      27,500 BTUH

**NOTE:** Performance is typical and based on operation at 23°C (73°F) ambient and nominal input voltage. This product is designed for use in a normal conditioned laboratory. Operation at higher ambient temperatures may result in decreased cooling performance. Additional ports and shelves will also affect performance. Operation above 30°C (85°F) or below 16°C (60°F) ambient is not recommended.

***F4 Temperature Controller Specifications***

---

Specifications as configured for the TestEquity 3007C Chamber

|  |   |
|--|---|
| <b>Accuracy &amp; Sensor Conformity*</b> | $\pm 1.55^{\circ}\text{C}$ (above $-50^{\circ}\text{C}$ )<br>$\pm 1.66^{\circ}\text{C}$ (below $-50^{\circ}\text{C}$ )  |
| <b>Stability</b>                         | $\pm 0.1^{\circ}\text{C}/^{\circ}\text{C}$ rise in ambient  |
| <b>Digital Inputs</b>                    | (Four) Contact closure or dc voltage, 10 k $\Omega$ impedance   |
| <b>Retransmit Outputs (Optional)</b>     | (Two) User-selectable ranges:<br>0 to 10 VDC, 0 to 5 VDC, 1 to 5 VDC<br>0 to 20 mA, 4 to 20 mA  |
| <b>Alarm Outputs</b>                     | (Two) Electromechanical relay;<br>Form C, 2 A @ 20 VDC or 240 VAC max.  |
| <b>Digital Outputs</b>                   | (3 available for customer use) Open collector output<br>OFF: 42 VDC @ 10 $\mu\text{A}$ max.<br>ON: 0.2 VDC @ 50 mA sink max.<br>Internal supply: 5 VDC @ 80 mA  |
| <b>Communications</b>                    | EIA-232 and EIA-485 serial communications with<br>Modbus™ RTU protocol  |
| <b>Safety &amp; Agency Approvals</b>     | UL/c-UL 916-listed, File #E185611<br>CE to EN61010<br>NEMA 4X and IP65<br>CE EMC to EN50082-2<br>CE EMC to EN55011  |
| <b>Displays</b>                          | <b>Process:</b> 5, seven-segment red LED.<br><b>Interface Display:</b> 4-line high-definition green LCD;<br>selectable $^{\circ}\text{C}$ or $^{\circ}\text{F}$ |
| <b>Data Retention</b>                    | Retention upon power failure via nonvolatile memory<br>(seven years for battery-backed RAM)   |

**\*Note:** Total system accuracy in the chamber includes thermocouple wire accuracy. Thermocouple wire accuracy is  $\pm 1^{\circ}\text{C}$  or 0.75% of reading, whichever is greater. Therefore, total system accuracy over the chamber's operating range can be as much as  $\pm 2.66^{\circ}\text{C}$ , although the typical accuracy is often better than  $\pm 1.0^{\circ}\text{C}$ .

## Chapter 8 – Maintenance

⚠ **WARNING:** Maintenance must be performed by properly trained personnel only.

### ***Preventive Maintenance Intervals***

---

#### **Daily or As Needed**

- Clean chamber interior and exterior.
- Listen for abnormal noise or vibration.

#### **Every 3 Months**

- Inspect the door seal.
- Inspect the refrigeration machinery compartment.
- Check the low-stage refrigeration charge.
- Check the high-stage refrigeration charge.
- Verify the chamber performance.

#### **Every 6 Months**

- Inspect the electrical compartment.
- Clean the condenser.

#### **Every 12 Months**

- Verify the calibration.

### ***Maintenance Procedures***

---

#### **How to clean the chamber interior and exterior**

- Wipe or vacuum out all debris.
- Clean surfaces with a damp cloth, mild detergent, or stainless-steel cleaner. Avoid cleaners that are abrasive or leave a residue. Do NOT use steel wool.
- If you clean the interior with something other than water, you may want to operate the chamber at high temperature (approximately +125°C) after cleaning. This helps to “bake out” any residue. Remove the port plugs to permit the residual vapors to escape.
- Clean the silicone door gaskets with a damp cloth or mild detergent.
- Clean the exterior painted surfaces with a damp cloth or mild detergent. If you are using a detergent, test a small inconspicuous area to make sure it does not damage the finish.

#### **How to listen for abnormal noise or vibration**

You should become familiar with normal operating noises. Being able to recognize changes from normal operating noises can be a valuable way to identify problems and prevent further damage. Examples of noises to be aware of include:

- Circulator motor and fan noises (with compressors off).
- Compressor start-up and running noises, sequential starting of compressors.
- Condenser fan noises.
- Relay and valve cycling noises when cool light is cycling.

#### **How to inspect the door seal**

The door has two silicone gaskets to minimize thermal losses and moisture migration.

- Inspect the gaskets for dirt and tears.
- Repair minor tears with a high quality RTV silicone such as GE RTV167.
- Check the integrity of the door seal by closing the door on a sheet of paper. With the door closed, slowly pull the paper. You should feel the resistance getting lighter as the paper goes past the inner gasket. Repeat this all around the door at several places.
- If the seal is not tight, adjust the door latch. The stainless-steel catch (on the bracket that is mounted to the chamber) has slotted holes to permit adjustment.
- If the seal is still loose on the hinge side, adjust the door hinge. The hinges have slotted holes (on the door side) to permit adjustment.

### How to inspect the refrigeration machinery compartment

**△ WARNING:** Wear safety goggles when inspecting the machinery compartment to protect against a refrigerant line which could break.

1. Turn the Main Disconnect Switch OFF.
2. Remove the side and rear panels.
3. Inspect for signs of refrigeration tubing abrasion.
4. Inspect for oil around refrigeration valves, fittings and joints. This may be a sign of leaks.
5. Inspect for loose hardware and tighten as required.
6. Inspect for signs of insect or rodent infestation. Yes, it does happen!

### How to check the low-stage refrigerant charge

The low-stage refrigerant charge is checked by observing the “standby pressure” (also known as static or balance pressure).

1. Make sure the chamber has been off for at least 8 hours.
2. Locate the two low-stage gauges marked R-508B on the left side of the rear of the chamber.
3. The two gauges have different scales. However, they should read the same value of pressure. This indicates that the system is equalized and an accurate reading can be taken.
4. Both R-508B gauges should read approximately 132 PSIG.
5. If the pressure is low, this indicates that there is probably a leak.
6. If one gauge is low and the other is high, then the system is not equalized yet and an accurate reading cannot be made. Wait until both gauges read the same pressure.

**NOTE:** If the low-stage has been evacuated and recharged after a repair, the standby pressure should be rechecked after 24 hours to make sure it is 132 PSIG. This is because the R-508B refrigerant mixes with the oil in the compressor, causing a lower standby pressure. Do not mistake this initial loss of pressure with a leak. After verifying that there is no leak, you may need to top-off the charge if the pressure is too low. This note only applies to systems that have been evacuated and recharged.

### How to check the high-stage refrigerant charge

The high-stage refrigerant charge is checked by observing the sightglass.

1. The sight glass is located behind the rear bottom panel, on the right side.
2. Set the Temperature Controller to a low-temperature Set Point. The Cool Light should be on continuously.
3. After about 5 minutes of operation in this mode, inspect the sightglass.
4. If you see bubbles or it appears partially full, then this indicates that there is probably a leak.
5. When the Temperature Controller is cycling (Cool Light cycles on/off), the sightglass may appear 1/2 to 2/3 full. This is normal.

### How to verify the chamber performance

These tests verify the performance of the heating, refrigeration, electrical controls, temperature controller, and air circulation systems. The chamber should meet all published performance specifications if all of these tests are successfully passed.

These tests assume that the Temperature Controller's setup and tuning values have not been changed from the values as shipped from TestEquity. Also, the Limit Controller high limit must be set to over +85°C (+88°C would be fine), and the low limit set to -75°C.

If the chamber fails any of these tests, it should be removed from service to prevent further damage until the cause of the problem is determined and resolved.

1. The chamber interior should be empty and at ambient temperature, approximately +23°C.
2. Set the Temperature Controller Set Point to +85°C
3. Turn the Master Switch ON. Turn Event 1 (DigitalOut 1 on the F4 Controller) ON.
4. The Heat Light should be ON continuously and the Cool Light should be OFF.
5. The chamber should heat up to about +80°C and begin controlling (Heat Light cycles ON/OFF) within approximately 3 minutes.
6. The chamber temperature should slowly increase and stabilize to +85°C. It should NOT overshoot beyond +85°C by more than a few tenths of a degree, and the compressors should NOT need to turn ON in order to maintain +85°C.
7. After stabilization, the chamber temperature should vary no more than  $\pm 0.5^\circ\text{C}$ , or a total of 1°C.
8. Let the chamber stay at +85°C for two hours.
9. After two hours at +85°C, set the Temperature Controller Set Point to -65°C.
10. The compressor should turn ON within a few seconds and the Heat Light should be OFF. After another 30 seconds, the Cool Light should be ON continuously.
11. The chamber should cool down to about -60°C and begin controlling (Cool Light cycles ON/OFF) within approximately 15 minutes.
12. The chamber temperature should slowly decrease and stabilize to -65°C. It should NOT undershoot beyond -65°C by more than a few tenths of a degree, and the compressors should NOT need to turn OFF in order to maintain -65°C.
13. After stabilization, the chamber temperature should vary no more than  $\pm 0.5^\circ\text{C}$ , or a total of 1°C.
14. Set the Temperature Controller Set Point to +23°C. The chamber should begin to heat up. The compressors should turn off within approximately 1 minute.
15. This concludes the chamber performance verification tests.
16. Let the chamber heat up to +23°C before turning the Master Switch OFF.

### How to inspect the electrical compartment

1. Disconnect the chamber from the power source.
2. Turn the Main Disconnect Switch to the OFF position.
3. Remove the lower door retaining screw located on the right side. Open the lower door.
4. Check for loose components, loose wires, burned insulation near terminals, and burned or excessively pitted contacts on contactors.

### How to clean the condenser

1. Disconnect the chamber from the power source.
2. Turn the Main Disconnect Switch to the OFF position.
3. Remove the lower door retaining screw located on the right side. Open the lower door.
4. Clean the condenser and desuperheater fins with a vacuum cleaner.

**NOTE:** You may need to clean the condenser more frequently if the chamber is in a dusty environment. You may be able to clean the condenser less frequently if the chamber is in a very clean environment.

### How to verify the calibration

TestEquity recommends verifying the calibration before attempting to actually perform a calibration. The state-of-the-art instrumentation used in TestEquity chambers is of the highest quality and seldom goes out of calibration. If you try to calibrate the instrumentation before determining that calibration is necessary, you may make it worse if done incorrectly.

Variations in temperature throughout the chamber interior are NOT a measurement of accuracy. These variations, called “gradients”, are a function of the physical design of the chamber and its airflow, the characteristics of the test sample, and how it is oriented in the chamber. You cannot “calibrate” to improve gradients. The correct way to adjust what the temperature controller “displays” compared to what is measured at some point other than the controller’s sensor, is with the “Calibration Offset” parameter. See page 6.2 of the “Series F4 User’s Manual” for details. Calibration verification should be performed with the Calibration Offset set to 0.0 (zero).

The F4 Temperature Controller accuracy is specified  $\pm 1.55^{\circ}\text{C}$  (above  $-50^{\circ}\text{C}$ ) and  $\pm 1.66^{\circ}\text{C}$  (below  $-50^{\circ}\text{C}$ ). Total system accuracy in the chamber includes the controller plus the thermocouple wire accuracy of  $\pm 1.0^{\circ}\text{C}$ . Total system accuracy over the chamber’s operating range is can be as much as  $\pm 2.66^{\circ}\text{C}$ , although it is typically better than  $\pm 1.0^{\circ}\text{C}$ .

The easiest way to verify the instrumentation accuracy is with an independent calibrated temperature sensor and display. Place the sensor near the chamber’s sensors, which are located towards the right side of the conditioner fan grille. If the readings agree within the specified limits above, then no calibration adjustments are necessary.

If calibration of the temperature controller is necessary, refer to page 9.2 of the “Series F4 User’s Manual” and follow the instructions for “Thermocouple Input Procedure”.

## ***Theory of Operation***

---

### **Overview**

The chamber is heated by an open element nichrome heater. Cooling is accomplished by a cascade refrigeration system. The air is circulated by two blowers. The heater, evaporator (cooling coil), and blowers are located within an air plenum which is on the back wall of the chamber interior.

The heater, compressor, and circulator fan motor operate directly from the 208/230 VAC input line. All line branch circuits are individually fused. A stepdown transformer provides 115 VAC for all instrumentation and control elements. Refer to the electrical and refrigeration drawings to identify the referenced items described below.

### **Heating System**

The chamber is heated by an open-element nichrome heater (HT1). The heater is located in the air plenum. The temperature controller provides a time-proportioned output to the solid state relays (SSR1, 2). This turns the heater on/off as required to maintain the temperature set point. SSR1 is controlled by the F4 Controller's Heat Output (F4-1A). SSR2 is controlled by the F4 Controller's Boost Heat Output (Digital Output 6). Relay CR5 disables the boost heat capability when the refrigeration system is running in order to reduce the power consumption. Pilot light PL1 provides an indication on the front panel when the heater is on.

Fusible heat limiters (HL1, 2, 3) provide failsafe protection against a catastrophic failure by opening the heater circuits at +240°C. The master heat contactor C1 provides a power interlock for the heaters, circulator fan motor, and the control system. C1 is controlled by both the Master Switch, the safety relay (CR3), and the phase control relay (PCR1). CR3 is controlled by the temperature limit controller (TCR2). If either the high or low temperature safety limits are exceeded, TCR2 turns off CR3, which turns off C1. PCR1 will disable CR1 if the input power phase-sequence is incorrect.

### **Refrigeration System**

Cooling is accomplished by a cascade refrigeration system. A cascade refrigeration system consists of two interdependent refrigeration systems. The low-stage provides cooling to the chamber interior through a finned evaporator coil, which is located in the air plenum. The high-stage provides cooling to the cascade condenser. The cascade condenser is a heat exchanger that has one circuit which is the evaporator of the high-stage, and another circuit which is the condenser of the low-stage.

The high-stage uses refrigerant R-404A. High pressure liquid refrigerant is fed from the condenser through the liquid line, filter-drier, and sight glass to the thermostatic expansion valve. The thermostatic expansion valve controls the feed of liquid refrigerant to the evaporator circuit of the cascade condenser and, by means of an orifice, reduces the pressure of the refrigerant to the evaporating or low side pressure. The reduction of pressure on the liquid refrigerant causes it to boil or vaporize, absorbing heat which provides a cooling effect. The refrigerant vapor travels through the suction line to the compressor suction inlet. The compressor takes the low pressure vapor and compresses it, increasing both the pressure and the temperature. The hot, high pressure vapor is forced out of the compressor discharge valve and into the condenser. As the high pressure vapor passes through the condenser, it is cooled by a fan, which blows ambient air

across the finned condenser surface. The vapor condenses into a liquid and the cycle is repeated. During heavy load conditions as determined by the discharge pressure of the low-stage, pressure control PS3 energizes solenoid valve SV3 which allows an additional expansion valve to feed the cascade condenser inlet for increased capacity.

The Low-Stage uses refrigerant R-508B. High pressure liquid refrigerant is fed from the condenser circuit of the cascade condenser, through the filter-drier and liquid-line solenoid valve to the thermostatic expansion valve. The thermostatic expansion valve feeds the finned evaporator coil, which is located in the air plenum where heat is absorbed to provide a cooling effect within the chamber. The refrigerant vapor travels through the suction line to the compressor suction inlet. The compressor takes the low pressure vapor and compresses it, increasing both the pressure and the temperature. The hot, high pressure vapor is forced out the compressor discharge valve and into the desuperheater. The desuperheater removes some of the heat of compression. Next, the vapor goes through the oil separator, which returns any entrained oil back to the compressor's crankcase. The vapor flows through the condenser circuit of the cascade condenser, where it is condensed back into a liquid.

The temperature controller cycles the low-stage liquid-line solenoid valve (SV1) ON/OFF to control the chamber temperature. When SV1 is ON, liquid refrigerant flows through the thermostatic expansion valve and evaporator to cool the chamber. When SV1 is OFF, the flow stops. The hot gas bypass solenoid valve (SV2) is ON whenever SV1 is OFF. SV2 feeds high pressure vapor to the hot gas regulator, which meters a precise amount into the suction line to maintain a minimum load on the system and keep it out of a vacuum. The hot gas regulator is adjusted to keep the suction pressure at 8 PSIG when SV1 is OFF. This is also called "bypass mode". The temperature controller alternately cycles SV2 and SV1 through cool relay CR1. Pilot Light PL2 provides an indication on the front panel when SV1 is ON.

During a high temperature pulldown or a continuous bypass condition, it is possible for excessive hot gas to return to the compressor. A suction line cooling thermostatic expansion valve (on both high- and low-stages) senses the suction line temperature and injects liquid refrigerant to cool the hot gas within safe limits.

The low-stage discharge pressure is kept within safe limits with the discharge pressure regulator valve. If the discharge pressure exceeds 285 PSIG, the discharge pressure regulator valve will "dump" refrigerant into the expansion tank. This refrigerant is slowly returned from the expansion tank to the suction line through a capillary tube. The expansion tank also provides sufficient volume in the system to keep the "standby pressure" (also known as static or balance pressure), when the system is off, within safe limits.

Both the high- and low-stages each have a high/low pressure switch which turns off the entire refrigeration system in the event of an out of limit condition. The high-stage compressor has a crankcase heater to prevent refrigerant from condensing in the oil when the compressor is off.

The temperature controller has internal logic to turn the compressors on if cooling is required to maintain the temperature set point. The low-stage compressor turns on 30 seconds after the high-stage turns on through Timing Module TM1. This reduces the system's starting current, while allowing the cascade condenser to get cool before the low-stage turns on.

***Troubleshooting***

| SYMPTOM                                   | CONDITION  | CAUSES   |
|---|--|--|
| <b>Chamber completely inoperative.</b>    | <ol style="list-style-type: none"> <li>1. Power is applied to chamber but nothing lights up.</li> </ol>  | <ol style="list-style-type: none"> <li>1. Incorrect phase sequence. Reverse two of the input lines.</li> <li>2. Control fuse F3 open. Likely cause is shorted solenoid coil on SV1 or SV2.</li> </ol>  |
| <b>Does not heat up at all.</b>           | <ol style="list-style-type: none"> <li>1. If controller light 1A is ON, circulator fan is ON, the Heat light is OFF.</li> <li>2. If controller light 1A is ON, circulator fan is ON, the Heat light is ON.</li> </ol>                                | <ol style="list-style-type: none"> <li>1. Solid State Relay SSR1 or SSR2 is defective.</li> <li>2. At least two Heat Limiters HL are open.</li> </ol>  |
| <b>Heats up too slow.</b>                 | <ol style="list-style-type: none"> <li>1. Does not meet published specifications.</li> </ol>   | <ol style="list-style-type: none"> <li>1. Chamber interior is overloaded. Port plug is not in port. Verify that input voltage is within tolerance. One heat limiter HL or one heater winding is open.</li> <li>2. F4 Controller's Boost Heat output is misconfigured.</li> </ol> |
| <b>Heat is on all the time.</b>           | <ol style="list-style-type: none"> <li>1. If temperature controller light 1A is OFF, the Heat light is ON.</li> </ol>  | <ol style="list-style-type: none"> <li>1. Solid State Relay SSR1 or SSR2 is defective. Heater is shorted to chassis.</li> </ol>  |
| <b>Does not cool at all.</b>              | <ol style="list-style-type: none"> <li>1. If temperature controller light 1B is ON, the Cool light is OFF, both compressors are OFF.</li> <li>2. If temperature controller light 1B is ON, the Cool light is ON, both compressors are ON.</li> </ol> | <ol style="list-style-type: none"> <li>1. Pressure switch DPS1 or DPS2 is tripped.</li> <li>2. Solenoid valve SV1 may be defective in closed position.</li> </ol>  |
| <b>R-404A pressure switch DPS1 trips.</b> | <ol style="list-style-type: none"> <li>1. Trips shortly after turn on.</li> <li>2. Trips after operating for a while.</li> </ol>   | <ol style="list-style-type: none"> <li>1. Ambient temperature may be too high. Low charge (leak).</li> <li>2. Dirty condenser, inadequate clearance from back of chamber to the wall. R-404A hot gas bypass regulator may be defective or set too low.</li> </ol>                |
| <b>R-508B pressure switch DPS2 trips.</b> | <ol style="list-style-type: none"> <li>1. If cooling from high to low temp is reduced.</li> <li>2. Trips during a high temp pull down.</li> <li>3. Trips when the cool light cycles from on to off.</li> </ol>                                       | <ol style="list-style-type: none"> <li>1. Low charge (leak).</li> <li>2. R-508B discharge pressure regulator may be defective.</li> <li>3. Solenoid valve SV2 may be defective. Hot gas bypass regulator may be defective or set too low.</li> </ol>                             |

## Chapter 8 – Maintenance

| SYMPTOM  | CONDITION  | CAUSES  |
|--|--|---|
| <b>R-508B standby pressure is less than 132 PSIG.</b>            | 1. When unit is off and system is equalized.   | 1. Low charge (leak).   |
| <b>R-404A sightglass has bubbles or does not look full.</b>      | 1. During all running conditions.<br>2. Only when cool light is cycling.   | 1. Low charge (leak).<br>2. No problem. This is normal.   |
| <b>Cools too slow or does not reach -73°C.</b>                   | 1. R-508B standby is ok, no bubbles in R-404A sightglass.  | 1. Chamber interior is overloaded. Test sample is energized, giving off heat. Circulator motor is not turning. Port plug is not in port. Door is not sealing completely. Ice on evaporator.   |
| <b>Cools all the time.</b>                                       | 1. When cool light is OFF.   | 1. Solenoid valve SV1 may be defective in open position.  |
| <b>Temperature varies more than ±0.5°C or 1°C total.</b>         | 1. If tuning PID control parameters in temperature controller were changed.<br>2. If tuning PID control parameters in temperature controller are as shipped from TestEquity.<br>3. If tuning PID control parameters in temperature controller are as shipped from TestEquity and only occurs in cool mode. | 1. Re-enter values as shipped from TestEquity.<br>2. Control parameters may need to be changed for your unique test conditions.<br>3. Control parameters may need to be changed for your unique test conditions. R-508B hot gas bypass regulator may be defective or set too high. R-508B expansion valve may be defective. |
| <b>Compressors turn on and off too frequently.</b>               | 1. If compressor control parameters in temperature controller were changed.<br>2. If compressor control parameters in temperature controller are as shipped from TestEquity.   | 1. Re-enter values as shipped from TestEquity.<br>2. Control parameters may need to be changed for your unique test conditions. Solenoid valve SV1 may be defective in open position.   |
| <b>Excessive noise and vibration when the compressor starts.</b> | 1. Chamber has been off for several hours or more and is not connected to source of power, or main disconnect switch is off during that time.<br>2. Chamber has been off for several hours or more, and is connected to source of power and main disconnect switch is on during that time.                 | 1. The chamber must be connected to the power source AND the main disconnect switch must be on for 3 hours prior to operating the chamber.<br>2. Crankcase heater defective (open).   |

## **Refrigeration System Charging Instructions**

**⚠ WARNING:** Repair of the refrigeration system must be performed only by a properly trained mechanic who is experienced in repairing cascade refrigeration systems. Do NOT substitute any component. Do NOT substitute refrigerants. Improper repairs will void the warranty.

These instructions are intended as guidelines for repairing TestEquity chambers. Details such as how to attach a gauge manifold are not covered. These are NOT do-it-yourself instructions!

### **R-404A High-Stage Charge**

TestEquity does NOT recommend charging the system by relying on a clear sight glass only. Although a clear sight glass generally means the system is fully charged, it can be misleading. For example, if the system is charged on a cool day or with an empty chamber, it could be undercharged for hot days or with a heavy load. The proper charging procedure is as follows:

1. Repair any leaks before recharging.
2. Attach a vacuum pump and manifold gauge to the suction and discharge ports.
3. Evacuate the system to at least 100 microns. DO NOT GUESS! You must use a micron gauge.
4. Use a charging scale to weigh in 100 ounces (6.25 pounds) of R-404A.
5. Verify the cooling performance as outlined in “How to verify the chamber performance”.

NOTE: If the Temperature Controller is cycling (Cool Light cycles on/off), the sightglass may appear 1/2 to 2/3 full. This is normal.

### **R-508B Low-Stage Charge**

1. Repair any leaks before recharging.
2. Attach a vacuum pump and manifold gauge to the suction, discharge, and expansion tank ports. Attaching to the expansion tank is very important because it is otherwise very difficult to evacuate the tank through the pressure regulator or capillary tube that connects it to the system.
3. Evacuate the system to at least 100 microns. Do NOT guess! You must use a micron gauge.
4. Do NOT put any additives in the system. Pentane is NOT necessary or desirable.
5. Charge the system until the standby pressure is 142 PSIG. Allow time for the charge to equalize as read on the suction and discharge gauges. This is 10 PSIG higher than the target amount of 132 PSIG. See NOTE below.
6. Verify the cooling performance as outlined in “How to verify the chamber performance”.

NOTE: If the low-stage has been evacuated and recharged, the standby pressure should be rechecked after 24 hours to make sure it is 132 PSIG. This is because the refrigerant mixes with the POE oil in the compressor, causing a lower standby pressure than was initially observed. Do not mistake this initial loss of pressure with a leak. After verifying that there is no leak, you may need to top-off the charge if the pressure is too low.

### ***Recommended Spare Parts***

---

Replacement parts are available from TestEquity. Parts are generally in-stock and ready for immediate shipment. Next-day delivery is always available. If you cannot risk being out of service for even one day, then you should purchase critical spare parts in advance. Although most parts are standard and available from a variety of local distributors, some parts are either harder to find or custom.

The following is a list of the kinds of parts that you may want to purchase in advance.

#### **Electrical Parts**

- Contactors
- Relays
- Fuses
- Heat Limiter
- Circulator Motor and Fan
- Switches

#### **Refrigeration Parts**

- Solenoid Valves
- Expansion Valves
- Regulator Valves

## Chapter 8 – Maintenance

### **Major Electrical Parts**

| <b>Description</b>                    | <b>Mfr</b>    | <b>Mfr Part No.</b> | <b>Ref #</b> | <b>Part #</b> | <b>Qty</b> | <b>UOM</b> |
|---------------------------------------|---------------|---------------------|--------------|---------------|------------|------------|
| Audible Alarm                         | Floyd Bell    | MC-09-201-Q         | AL1          | 200005        | 1          | ea         |
| Arc Suppressor                        | ITW Paktron   | 104MACQRL150        | AS1, 2, 5    | 200296        | 3          | ea         |
| Contact, 3 P 30A                      | Hartland      | HCC-3XT02SX         | C1-3         | 200245        | 3          | ea         |
| Relay, Octal DPDT 10A 120VAC          | Idec          | RR2P-UCAC120        | CR1, 3, 4    | 200292        | 3          | ea         |
| Relay, SPDT 5A 120VAC                 | Omron         | G2R-1-T-AC120       | CR5          | 200160        | 1          | ea         |
| Disconnect Switch, 3 Pole, 45A        | ABB           | OT63F3              | DSW          | 200281        | 1          | ea         |
| Fuse, 4A                              | Bussman       | FNQ-R-4             | F1, 2        | 200083        | 2          | ea         |
| Fuse, 3A                              | Bussman       | FNM-3               | F3           | 200186        | 1          | ea         |
| Fuse, 20A                             | Bussman       | FNQ-R-20            | F4-6         | 200242        | 3          | ea         |
| Fuse, 20A                             | Bussman       | LP-CC-20            | F7-12        | 200206        | 6          | ea         |
| Circulator Motor, 230V 1725 RPM       | CUSTOM        | CUSTOM              | FM3, 4       | 222330        | 2          | ea         |
| Heat Limiter                          | Thermodisc    | G5A-01-240C         | HL1-3        | 200070        | 3          | ea         |
| Heater, Air                           | CUSTOM        | CUSTOM              | HT1          | 222340        | 1          | ea         |
| Appliance Light, 40W, 120V            | Generic       | Generic             | LT1          | 300096        | 1          | ea         |
| Indicator, Panel, 240V Neon           | SoLiCo        | S412-2-1-N2         | PL1          | 200026        | 1          | ea         |
| Indicator, Panel, 120V Neon           | SoLiCo        | S412-2-1-N1         | PL2          | 200025        | 1          | ea         |
| Relay, Phase Control                  | Crouzet       | DWRS220A            | PVR1         | 200067        | 1          | ea         |
| Resistor, 10 k, 5 W                   | Vishay/Dale   | 71-RH00510K00FE02   | R1           | 222334        | 1          | ea         |
| Solid State Relay, 25A                | Siemens       | SSRT-240D25         | SSR1, 2      | 200021        | 2          | ea         |
| Solid State Relay, 10A                | Omron         | G3NE-210T-US DC5    | SSR3-6       | 200129        | 4          | ea         |
| Solid State Relay, 5A                 | Omron         | G3NA-205B-DC5-24    | SSR7-9       | 200032        | 3          | ea         |
| Switch, SPST, Rocker                  | Carlingswitch | LRA211-RA-B/125N    | SW1          | 200023        | 1          | ea         |
| Switch, ON-OFF-ON                     | Carlingswitch | RC911-RA-B-0-N-XLR1 | SW2          | 200275        | 1          | ea         |
| Temperature Controller                | Watlow        | F4SH-CKA0-01AE      | TCR1         | 200001        | 1          | ea         |
| High/Low Limit Controller             | Watlow        | PM6L1AJ-AAAABBS     | TCR2         | 200301        | 1          | ea         |
| Timing Module                         | Airotronics   | THCU30SC            | TM1          | 200287        | 1          | ea         |
| Control Transformer                   | Hammond       | PH350MLI            | TR1          | 200219        | 1          | ea         |
|                                       |               |                     |              |               |            |            |
| <b>Chart Recorder Option</b>          |               |                     |              |               |            |            |
| Recorder, 1 Pen, 10"                  | Honeywell     | DR4301-0000-G0100   | RCD1         | 200094        | 1          | ea         |
| Chart paper, -90 to 210 C             | Honeywell     | 24001660-034        |              | 200095        | 1          | ea         |
| Chart paper, -130 to 410 F, Alternate | Honeywell     | 24001660-033        |              | 200096        | 1          | ea         |
| Pen, Purple, Six Pack                 | Honeywell     | 30735489-007        |              | 200097        | 1          | ea         |

## Chapter 8 – Maintenance

### Major Refrigeration Parts

| Description                       | Mfr           | Mfr Part No.                | Ref #           | Part # | Qty | UOM |
|-----------------------------------|---------------|-----------------------------|-----------------|--------|-----|-----|
| Capillary Tube, 0.050 x 12"       | J/B           | TC-50                       | 21              | 100019 | 1   | ea  |
| Cascade Condenser                 | Flat Plate    | CH3-1/2                     | 27              | 100072 | 1   | ea  |
| Compressor                        | Copeland      | ZF11K4E-TF5-241             | 1 (part of), 17 | 100059 | 2   | ea  |
| Crankcase Heater, 40 W, 120 V     | Copeland      | 018-0041-01                 | 2 (CC1)         | 100071 | 1   | ea  |
| Desuperheater Coil                | CUSTOM        | CUSTOM                      | 16              | 100621 | 1   | ea  |
| Discharge Pressure Regulator      | Sporlan       | ORI-6-80/325-H              | 23              | 100069 | 1   | ea  |
| Distributor                       | Sporlan       | D260-2-1/4-2-L              | 7               | 100491 | 1   | ea  |
| Dual Pressure Switch              | Johnson       | P70NA-1C                    | 11 (DPS1, 2)    | 100015 | 2   | ea  |
| Evaporator Coil                   | CUSTOM        | CUSTOM                      | 8               | 100620 | 1   | ea  |
| Expansion Tank                    | Ref. Research | 9027                        | 22              | 100075 | 1   | ea  |
| Expansion Valve, HS               | Danfoss       | 068U2317                    | 24, 32          | 100471 | 2   | ea  |
| Expansion Valve, Main             | Danfoss       | 068U3317                    | 28              | 100487 | 1   | ea  |
| Expansion Valve, Suction Cool, HS | Sporlan       | SBFJ-AA-C                   | 25              | 100077 | 1   | ea  |
| Expansion Valve, Suction Cool, LS | Sporlan       | SBFS-B-ZP 3/8 x 5/8 odf     | 26              | 100507 | 1   | ea  |
| Filter Drier                      | Sporlan       | C-083-S                     | 4               | 100070 | 2   | ea  |
| Gauge, 0 x 400 PSIG Pressure      | Miljoco       | CUSTOM                      | 14              | 100495 | 2   | ea  |
| Gauge, 30" x 200 PSIG Compound    | Miljoco       | CUSTOM                      | 12              | 100494 | 2   | ea  |
| Hot Gas Bypass Regulator, HS      | Sporlan       | ADRI-1-1/4-0/55             | 10              | 100078 | 1   | ea  |
| Hot Gas Bypass Regulator, LS      | Sporlan       | ADRS-2-0/30                 | 29              | 100068 | 1   | ea  |
| Oil Separator                     | Temprite      | 901                         | 19              | 100537 | 1   | ea  |
| Orifice for 100471, 100487        | Danfoss       | 068U1037                    | 24A, 28A, 32A   | 100472 | 3   | ea  |
| Pressure Switch                   | Johnson       | P70AA-118C                  | 30 (PS3)        | 180119 | 1   | ea  |
| Sight Glass                       | Danfoss       | 140-0143                    | 3               | 100081 | 1   | ea  |
| Solenoid Valve                    | Sporlan       | XXF, 3/8 x 3/8 ODF Extended | 5               | 180117 | 1   | ea  |
| Solenoid Valve                    | Sporlan       | XUP, 3/8 x 3/8 ODF Extended | 6, 31           | 180118 | 2   | ea  |
| Solenoid Valve Coil               | Sporlan       | OMKC-1-120/50-60            | SV1, 2, 3       | 100344 | 1   | ea  |
| Strainer                          | Suppco        | S-218                       | 20              | 100050 | 1   | ea  |

### LN2 Parts (opt. 0018)

| Description                | Mfr         | Mfr Part No. | Ref #  | Part # | Qty | UOM |
|----------------------------|-------------|--------------|--------|--------|-----|-----|
| Solenoid Valve, LN2 Setup  | CUSTOM      | CUSTOM       | SV4    | 180100 | 1   | ea  |
| Solenoid Valve, LN2 Supply | CUSTOM      | CUSTOM       | SV3    | 180102 | 1   | ea  |
| Relief Valve               | Rego        | SS-9432      |        | 180104 | 1   | ea  |
| Arc Suppressor             | ITW Paktron | 104M06QC100  | AS3, 4 | 200296 | 2   | ea  |

### General Parts

| Description                   | Mfr        | Mfr Part No.                             | Ref # | Part #  | Qty | UOM |
|-------------------------------|------------|--|-------|---------|-----|-----|
| Port Plug, Silicone Foam, 4"  | CUSTOM     | CUSTOM                                   |       | 300534  | 2   | ea  |
| Viewing Window                | CUSTOM     | CUSTOM                                   |       | 300692  | 1   | ea  |
| Door Gasket                   | CUSTOM     | CUSTOM                                   |       | 300541  | 1   | ea  |
| Door Latch, Chamber Workspace | Southco    | A2-10-501-21                             |       | 300009  | 1   | ea  |
| Caster, Swivel                | RollMaster | 35-15-11                                 |       | 300011  | 2   | ea  |
| Caster, Rigid                 | RollMaster | 35-16-11                                 |       | 300012  | 2   | ea  |
| Shelf with 4 Clips            | CUSTOM     | CUSTOM                                   |       | TE-0701 | 1   | ea  |
| Shelf Retainer Clip           | Kason      | Style 66, #0066000008                    |       | 300015  | 4   | ea  |
| Blower Wheel, CW              | CUSTOM     | Required when replacing circulator motor |       | 382498  | 1   | ea  |
| Blower Wheel, CCW             | CUSTOM     | Required when replacing circulator motor |       | 382499  | 1   | ea  |
| Seal, Fan Motor Shaft         | CUSTOM     | Required when replacing circulator motor |       | 300286  | 2   | ea  |

### ***Series F4 Temperature Controller Setup Parameters***

---

- △ **CAUTION:** The “Series F4 User’s Manual” is a general manual and is written by the manufacturer, Watlow, for a wide variety of applications and configurations. Not all features or functions are applicable. Only the capabilities of a model F4SH-CKA0-01, as described on page A.7 of the “Series F4 User’s Manual” are applicable. “Cascade Control” as described on page 3.6 of the “Series F4 User’s Manual” is not applicable in this configuration. The “Retransmit” function is available as an option.
- △ **CAUTION:** The Series F4 Temperature Controller has been properly configured by TestEquity to match the chamber’s system requirements and to perform optimally over a wide range of operating conditions. Improper modifications to these setup values can result in erratic performance and unreliable operation. Setup examples in the “Series F4 User’s Manual” are NOT applicable to this chamber. Do not attempt to modify the setup values, unless you thoroughly understand what you are doing. If there is any doubt, please call TestEquity before proceeding.
- △ **CAUTION:** The alarm outputs of the Temperature Controller are NOT connected to the chamber’s safety system. TestEquity does NOT recommend using the Temperature Controller’s alarm function as the main protection device.
- △ **CAUTION:** NEVER select “Full Defaults” in the Factory/Test Menu. “Full Defaults” are NOT the TestEquity configuration parameters for this chamber. If you select “Full Defaults”, you must reconfigure all System and Operation Parameters as documented in the TestEquity manual, NOT the “Series F4 User’s Manual”.

TestEquity has configured the Temperature Controller with the parameters as documented on the following pages.

Series F4 Setup Parameters

|  |   |   |
|--|---|---|
| <p><b>System Menu</b><br/> <b>Main Page\Go to Setup\System</b><br/>                 GSB 1 Source           Input 1<br/>                 Guar. Soak Band 1     3.0 °C (5.4 if °F)<br/>                 Current Time           (local time)<br/>                 Current Date           (local date)<br/>                 PID Units               US, Reset/Rate<br/>                 °F or °C                °C<br/>                 Show °F or °C         Yes, Upper Display<br/>                 Ch1 Autotune SP       90%<br/>                 Input 1 Fail            0%<br/>                 Open Loop Ch1         Off<br/>                 Power-Out Time        10 Sec<br/>                 Power-Out Action      Continue</p> | <p><b>Alarm Output Menus</b><br/> <b>Main Page\Go to Setup\Alarm Output (1-2)</b><br/>                 Name                    No<br/>                 Alarm Type             Process<br/>                 Source                  Input 1<br/>                 Latching                Alarm Self-Clears<br/>                 Silencing               Yes<br/>                 Hysteresis             1.7 °C (3.0 if °F)<br/>                 Alarm Sides            Both<br/>                 Alarm Logic            Open on Alarm<br/>                 Show Message         Yes on Main Page</p>   | <p><b>Digital Output Menu</b><br/> <b>Main Page\Go to Setup\</b><br/> <b>Digital Output 1</b><br/>                 Name                    Yes<br/>                 Name Digital Out.     CONDITION<br/>                 Function                Event Output<br/> <b>Digital Output 2</b><br/>                 Name                    Yes<br/>                 Name Digital Out.     LN2<br/>                 Function                Event Output<br/> <b>Digital Output 3, 4, 5</b><br/>                 Name                    No<br/>                 Function                Event Output</p>   |
| <p><b>Analog Input Menu</b><br/> <b>Main Page\Go to Setup\Analog Input1</b><br/>                 Sensor                  Thermocouple<br/>                 Type                    T<br/>                 Decimal                 0.0<br/>                 SP Low Limit           -75.0 °C (-103.0 if °F)<br/>                 SP High Limit         175.0 °C (347.0 if °F)<br/>                 Calibration Offset     0.0<br/>                 Filter Time            1.0 sec<br/>                 Error Latch            Self-Clear</p>   | <p><b>NOTE:</b> The alarm outputs of the Temperature Controller are NOT connected to the chamber's safety system. TestEquity does NOT recommend using the Temperature Controller's alarm function as the main protection device.</p> <p><b>Retransmit Output Menu</b><br/>                 (if retransmit option is ordered)<br/> <b>Main Page\Go to Setup\Retransmit Output 1</b><br/>                 Retransmit Source    Set point 1<br/>                 Analog Range         0-5V<br/>                 Low Scale             -75.0°C (-103.0 if °F)<br/>                 High Scale            175.0°C (347.0 if °F)<br/>                 Scale Offset          0.0</p> | <p><b>Digital Output 6</b><br/>                 Name                    No<br/>                 Function                Boost Heat<br/>                 Boost % Power         50%<br/>                 Boost Heat Delay Time 1 sec<br/> <b>Digital Output 7</b><br/>                 Name                    No<br/>                 Function                Boost Cool<br/>                 Boost % Power         50%<br/>                 Boost Cool Delay Time 1 sec</p>   |
| <p><b>Digital Input Menus</b><br/> <b>Main Page\Go to Setup\Digital Input (1-4)</b><br/>                 Name                    No<br/>                 Function                Off</p>   | <p><b>Main Page\Go to Setup\Retransmit Output 2</b><br/>                 Retransmit Source    Input 1<br/>                 Analog Range         0-5V<br/>                 Low Scale             -75.0°C (-103.0 if °F)<br/>                 High Scale            175.0°C (347.0 if °F)<br/>                 Scale Offset          0.0</p>  | <p><b>Digital Output 8</b><br/>                 Function                Compressor<br/>                 Comp. On % Power     -2%<br/>                 Comp. Off % Power    0%<br/>                 Compressor Off Delay 60 sec<br/>                 Compressor On Delay 10 sec</p>  |
| <p><b>Control Output Menus</b><br/> <b>Main Page\Go to Setup\Control Output 1A</b><br/>                 Function                Heat<br/>                 Choose Cycle Time    Fixed Time<br/>                 Enter Cycle Time     3.0 sec<br/>                 Hi Power Limit        100 %<br/>                 Low Power Limit      0 %<br/> <b>Main Page\Go to Setup\Control Output 1B</b><br/>                 Function                Cool<br/>                 Choose Cycle Time    Fixed Time<br/>                 Enter Cycle Time     6.0 sec<br/>                 Hi Power Limit        100 %<br/>                 Low Power Limit      0 %</p>   | <p><b>Communications Menu</b><br/> <b>Main Page\Go to Setup\Communications</b><br/>                 Baud Rate             9600<br/>                 Address                1</p>  | <p><b>Custom Main Page Menu</b><br/> <b>Main Page\Go to Setup\Custom Main Page</b><br/>                 P1                    Current File<br/>                 P2                    Current Step<br/>                 P3                    Set Point 1<br/>                 P4                    Step Type<br/>                 P5                    Target SP1<br/>                 P6                    WaitFor Status<br/>                 P7                    Time Remaining<br/>                 P8                    Digital Outputs<br/>                 P9                    % Power 1<br/>                 P10                   Digital Inputs<br/>                 P11                   Date<br/>                 P12                   Time<br/>                 P13                   Custom Message 1<br/>                 P14-16               None</p> |
|  |   | <p><b>Static Page Menu</b><br/> <b>Main Page\Go to Setup\Static Message</b><br/>                 Message 1            TESTEQUITY 3007C</p>  |

## Series F4 Operations Parameters

|   |   |
|---|---|
| <p><b>PID Set Channel 1 Menu</b><br/> <b>Main Page\Go to Operations&gt;Edit PID\PID Set Channel 1\PID Set (1-5)</b><br/>                 Proportional BandA    5.0 °C (9.0 if °F)<br/>                 Reset A                    0.05 min<br/>                 Rate A                     0.00 min<br/>                 Dead Band A             0.0 °C<br/>                 Proportional BandB    5.0 °C (9.0 if °F)<br/>                 Reset B                    0.05 min<br/>                 Rate B                     0.00 min<br/>                 Dead Band B             0.0<br/>                 Hysteresis                0.0</p> | <p><b>Alarm Setpoints Menu</b><br/> <b>Main Page\Go to Operations\Alarm Setpoints\Alarm1</b><br/>                 Alarm1 Low SP        -75.0°C (-103.0° if °F)<br/>                 Alarm1 High SP        175.0 °C (347.0 if °F)<br/> <b>Main Page\Go to Operations\Alarm Setpoints\Alarm2</b><br/>                 Alarm2 Low SP        -75.0°C (-103.0° if °F)<br/>                 Alarm2 High SP        175.0 °C (347.0 if °F)</p> <p><b>NOTE:</b> The alarm outputs of the Temperature Controller are NOT connected to the chamber’s safety system. TestEquity does NOT recommend using the Temperature Controller’s alarm function as the main protection device.</p> |
|---|---|

## Series F4 Set Lockout Parameters

The Series F4 Controller has several levels of security to prevent unauthorized users from changing critical configuration parameters. Only the Set Point and Profile menus have “Full Access”. TestEquity has configured all other menus to “Password”, and have protected them with a password.

TestEquity does not recommend that these security levels be changed for most applications. However, there will be times when “Full Access” is necessary. For example, you may need to gain access to Setup Page in order to change from °C to °F display, or to change the time or date. You must call TestEquity at 877-512-3457 or 805-480-0638 to obtain the password.

### Set Lockout Menu

Main Page\Go to Factory\Set Lockout

|                    |             |
|--------------------|-------------|
| Set Point          | Full Access |
| Oper. Autotune PID | Password    |
| Oper. Edit PID     | Password    |
| Oper. Alarm SP     | Password    |
| Profile            | Full Access |
| Setup              | Password    |
| Factory            | Password    |

## **EZ-Zone Limit Controller Setup Parameters**

**△ CAUTION:** The EZ-Zone Limit Controller has been properly configured by TestEquity to match the chamber’s system requirements. Improper modifications to these setup values can result in erratic performance and unreliable operation. Do not attempt to modify the setup values, unless you thoroughly understand what you are doing. If there is any doubt, please call TestEquity before proceeding.

### **Setup Menu**

| Prompt                            | Function          | Setting                           | Alternate Setting                                      |
|-----------------------------------|-------------------|-----------------------------------|--|
| <input type="text" value="LoC"/>  | Lockout Menu      | <input type="text" value="2"/>    | See NOTE 1 below                                       |
| <input type="text" value="SEn"/>  | Sensor Type       | <input type="text" value="tC"/>   | Do Not Change  |
| <input type="text" value="Lin"/>  | Linearization     | <input type="text" value="t"/>    | Do Not Change  |
| <input type="text" value="dEC"/>  | Decimal           | <input type="text" value="0"/>    | Alt. “0.0”   |
| <input type="text" value="C_F"/>  | °C or °F          | <input type="text" value="C"/>    | Alt. “F”   |
| <input type="text" value="rLo"/>  | Range Low         | <input type="text" value="-75"/>  | Do not make any lower                                  |
| <input type="text" value="rhi"/>  | Range High        | <input type="text" value="180"/>  | Do not make any higher                                 |
| <input type="text" value="Fn2"/>  | Output 2 Function | <input type="text" value="L1P7"/> | Do Not Change  |
| <input type="text" value="LSd"/>  | Limit Sides       | <input type="text" value="both"/> | Alt. “high” (High only) or “LoW” (Low only)            |
| <input type="text" value="Lhy"/>  | Limit Hysteresis  | <input type="text" value="2"/>    | Change not recommended                                 |
| <input type="text" value="ALY"/>  | Alarm Type        | <input type="text" value="oFF"/>  | Do Not Change  |
| <input type="text" value="PAR1"/> | Upper Display     | <input type="text" value="RCPu"/> | Alt. “none”  |
| <input type="text" value="PAR2"/> | Lower Display     | <input type="text" value="LSE"/>  | Alt. “Lh.s” (High Set Point) or “LL.S” (Low Set Point) |
| <input type="text" value="AdS"/>  | Zone Address      | <input type="text" value="1"/>    | Not functional for this application                    |

NOTE 1: The Lockout Menu  sets the security clearance level as follows:

|                                |   |
|--------------------------------|---|
| <input type="text" value="1"/> | Operations Menu, read only  |
| <input type="text" value="2"/> | Operations Menu, set point read/write   |
| <input type="text" value="3"/> | Operations Menu, set point read or write (same as level 2)  |
| <input type="text" value="4"/> | Operations Menu, full access read/write (required to access Calibration Offset below)                   |
| <input type="text" value="5"/> | Operations Menu and Setup Menu full access (required to access Setup Menu and Calibration Offset below) |

### **Operations Menu**

| Prompt                           | Function           | Setting                          | Alternate Setting                                 |
|----------------------------------|--------------------|----------------------------------|---|
| <input type="text" value="LLS"/> | Low Set Point      | <input type="text" value="-75"/> | Appropriate Low Limit Set Point                   |
| <input type="text" value="LhS"/> | High Set Point     | <input type="text" value="180"/> | Appropriate High Limit Set Point                  |
| <input type="text" value=".CR"/> | Calibration Offset | <input type="text" value="0"/>   | Calibration Offset as required (see NOTE 2 below) |

NOTE 2: LoC parameter in Setup Menu must be set for 4 or 5 to access the Calibration Offset parameter.



## **Chapter 9 - Warranty**

### **TestEquity LLC Limited Warranty**

TestEquity LLC (TestEquity) warrants Environmental Chambers (Equipment) manufactured by TestEquity and supplied under this contract to be free from defects in materials and workmanship under normal use and proper maintenance.

TestEquity will repair or replace any defective part for a period of THREE YEARS from the date of invoice. TestEquity reserves the right to require any defective part be returned, freight prepaid, to TestEquity's factory or to inspect any defective part at the Purchaser's site. TestEquity shall have sole discretion to determine whether any part is defective and whether any defective part will be repaired or replaced. This limited warranty shall extend to any standard chamber accessory and component part which is normally sold by TestEquity. Non-standard accessories and component parts specified by the Purchaser shall be warranted only to the extent of the original manufacturer's warranty, if any exists.

If the repair or replacement is performed in the FIRST YEAR from the date of invoice, TestEquity will also pay for the labor associated with the repair at the Purchaser's site, subject to TestEquity's prior approval. During the SECOND and THIRD YEAR of the warranty period, Purchaser will be responsible for the installation and cost of installation of replacement or repaired parts. Purchaser shall notify TestEquity in writing of any alleged defect within 10 days after its discovery within the warranty period. TestEquity reserves the right to satisfy the labor portion of this limited warranty either through its own service personnel or an authorized agent. In order to provide expeditious service, TestEquity reserves the right to satisfy its limited warranty obligation by sending replacement parts to be installed by the Purchaser if they can be installed easily without special tools or training. TestEquity reserves the right to satisfy this limited warranty by requiring the Purchaser to return the Equipment to TestEquity when such return is feasible.

The following parts are excluded from this limited warranty and are sold as-is or are considered expendable: interior light bulb, viewing window, paint and cosmetic surface finishes and treatments, port plugs, and refrigerant.

This limited warranty shall extend in full to Equipment installed within continental United States and Canada. For all other locations, Purchaser is responsible for all labor costs for repairs or parts installation, and for all shipping costs associated with providing replacement parts.

This limited warranty does not cover: (1) Defects or damages arising as the result of shipment by common carriers or private transportation, unless TestEquity undertakes shipment and transportation of the Equipment to Purchaser's site or contractually assumes the risk of damage to the Equipment in shipment; (2) Defects or damages arising out of, or as the result, of mishandling, modification, or improper start up, installation or maintenance of the Equipment (including start up, installation or maintenance not in accordance with TestEquity's written procedures); (3) Defects or damages resulting from, or arising out of, abuse, misuse, neglect, intentional damage, accident, fire, flood, earthquake, or any other act of God.

This warranty as to Equipment is LIMITED to repair or replacement of parts or Equipment in the determination of TestEquity LLC THE FORGOING LIMITED WARRANTY IS IN LIEU OF ALL OTHER WARRANTIES INCLUDING THE IMPLIED WARRANTIES OF FITNESS FOR A PARTICULAR PURPOSE AND MERCHANTABILITY. TestEquity LLC DISCLAIMS ANY LIABILITY FOR ANY DAMAGES RESULTING FROM DELAY OR LOSS OF USE IN SERVICE OR REPAIR, OR FOR INCIDENTAL OR CONSEQUENTIAL DAMAGES ARISING OUT OF OR IN CONNECTION WITH THE USE OR PERFORMANCE OF THE EQUIPMENT, EXCEPT AS STATED IN THIS PARAGRAPH.

This limited warranty cannot be modified in any way except in writing by both TestEquity and Purchaser. Invalidation of any one or more of the provisions of this limited warranty shall in no way affect any of the other provisions hereof, which remain in full force and effect.

This limited warranty shall be extended only to the first Purchaser of this Equipment and is not transferable.



**Chapter 10 – Drawings**



## Electrical Subpanel Component Location

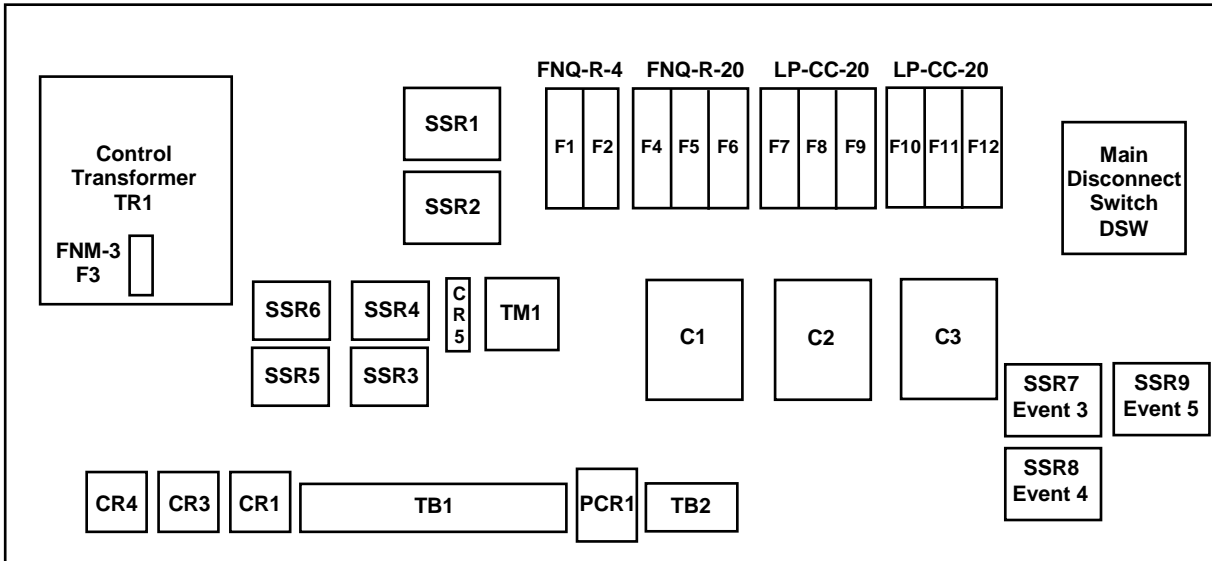

### TB1 Terminals

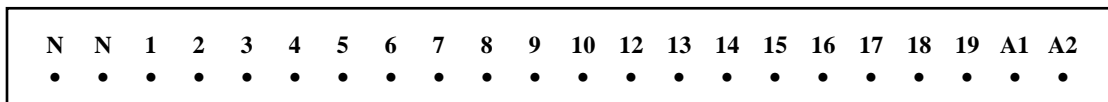

### TB2 Terminals

