

Application Note

Interference Testing with Handheld Spectrum Analyzers



Agilent Technologies

Table of Contents

Introduction	3
Wireless Systems and Interference	4
Radio Duplexing	6
Half-duplex.....	6
Full-duplex.....	6
Example: Duplexing’s role in interference identification.....	7
Sources of Interference	9
Example: Locating interference source.....	9
Interference categories.....	12
Receivers and Spectrum Analyzers	13
Receiver anatomy.....	13
Spectrum analyzer functionality.....	14
Power levels.....	15
Example: Properly setting power levels.....	16
Interference Measurement Procedure	19
Capturing intermittent signals.....	20
Estimating the interferer’s location.....	22
Interference Classifications and Measurement Examples	23
In-band interference.....	23
Co-channel interference.....	23
Out-of-band interference.....	24
Adjacent channel interference.....	26
Downlink interference.....	28
Uplink interference.....	28
Conclusion	28

Introduction

Wireless communications systems co-exist across the RF and microwave frequency spectrum and are designed to operate with a limited amount of interference. As wireless systems often share or reuse frequency spectrum, interference from other users can quickly become an issue. When the amplitude of an interfering signal becomes relatively large as compared to the signal of interest then the interference can reduce system performance in a variety of ways.

Commercial and government agencies working in industries such as cellular, broadcast radio and television, radar, and satellite are often required to continually monitor the frequency spectrum for interference from known and unknown signals, to ensure proper system performance and regulatory compliance.

For example, interference issues commonly occur when a transmitter is improperly radiating energy into the same or adjacent frequency channels. In some cases, the wireless signal may be interference to sensitive equipment such as the case when cellular transmissions in close proximity to electroencephalogram (EEG) monitors may obstruct the operation of the equipment. Since all wireless systems are subject to the effects of interference, it is important to be able to quickly and accurately measure the frequency spectrum in and around the wireless system.

This application note introduces the processes and techniques for measuring and locating wireless interference using a portable handheld spectrum analyzer (HSA). As interference testing may include carrier-specific measurements, wide bandwidth spectrum searching, data logging, and finding the location of the offending transmitter, the HSA requires several important characteristics. The test instrument needs to provide:

- a broad range of frequency coverage
- fast measurement sweeps
- high dynamic range
- data storage
- ruggedness
- portability

While there is a variety of test equipment available for accurately measuring the amplitude and frequency content of wireless signals, the Agilent N934xC Series and N9340B handheld spectrum analyzers (HSAs) are ideally suited when speed, accuracy, and portability are essential for field operations.

Wireless Systems and Interference

Wireless communications, traditionally known as radio communications, use radio waves operating with carrier frequencies in the range of 3 kHz to 300 GHz. While it appears that this radio spectrum is very wide, practical considerations, such as performance, power, and equipment cost typically limit most carrier frequencies from less than 6 GHz up to 20 GHz. Operators, including the majority of commercial, military, and public safety wireless systems, operate at carrier frequencies less than 6 GHz. Meanwhile, satellite and radar systems operate with carriers as high as 20 GHz and above.

As frequency spectrum is a limited resource, local government agencies regulate its use by assigning frequency ranges or “bands” to different types of systems in order to balance the interests of commercial, public safety, and military organizations.

For example, wireless local area network (WLAN) communications used in laptops and numerous handheld devices may operate with carrier frequencies over the 2.4 to 2.4835 GHz band or the 5.15 to 5.825 GHz band. Each of these frequency bands is typically sub-divided into frequency channels that are shared among all the users in the system. The channel spacing of WLAN systems varies between 5 and 20 MHz respectively. In contrast, a broadcast AM radio band operating over the frequency band from 520 to 1,710 kHz is subdivided into individual channels spaced by 9 or 10 kHz depending on the region.

The channel spacing is spread far enough apart so that adjacent channels on either side of the desired channel are filtered out by the receiver’s channel filter. Interfering signals that are close to the desired channel may pass through the channel filter and corrupt the receiver’s operation.

If a wireless system is experiencing performance issues, a spectrum analyzer can be used to examine the radio spectrum around the desired channel to verify whether the reduced performance is the result of interference within the operating channel or the adjacent channels.

Figure 1 shows the spectrum of a wireless signal for a WLAN system that was showing a lower than expected performance. For this measurement, the Agilent N9342C HSA was connected to an external antenna and positioned near the WLAN transceiver. Initially the spectrum appeared to be free of interference, though occasionally a small amplitude change was seen offset approximately 1 MHz from the center frequency. Once the system transmitter was switched off, it was discovered that a narrowband signal was transmitting in the same channel.

Wireless Systems and Interference (continued)

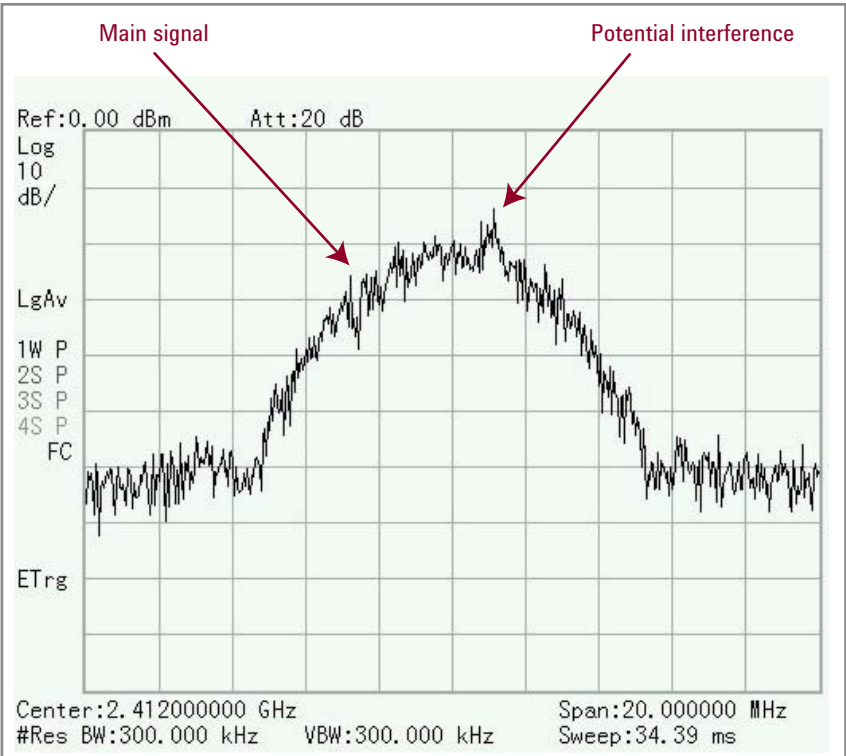

Figure 1. Measured spectrum of a discovered in-band interference when the main transmitter was switched on

Figure 2 shows the spectrum of this “in-band” interference with the WLAN transmitter switched off. Now that a potential cause was discovered for the performance problems, the next steps would be to find the location of the in-band interference and work to lower or eliminate the interference effect on the system.

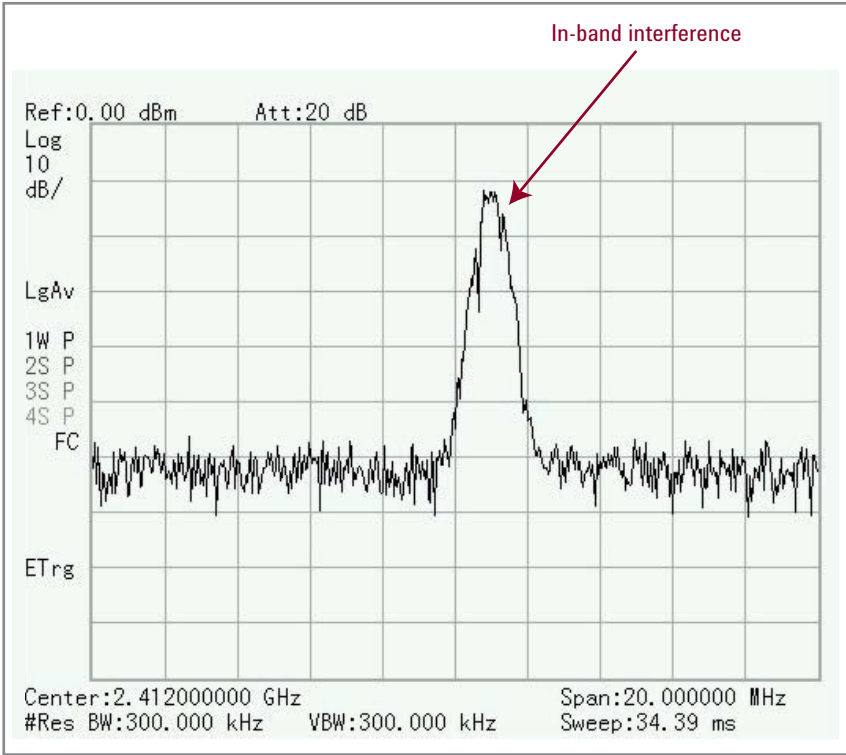

Figure 2. Measured spectrum of a discovered in-band interference when the main transmitter was switched off

Radio Duplexing

Knowing that the radio spectrum has a limited number of channels and the number of users continues to grow, many radio systems are designed to share a single frequency channel by dividing the transmission time among several users. This is called duplexing. For example, a cellular GSM mobile subscriber (MS) will transmit signals to the base transceiver station (BTS) using an assigned time slot along with the assigned frequency channel. The North American (NA) GSM 850 system divides a 4.615 millisecond length of time into 8 time slots for sharing the frequency channel between multiple users in order to increase system capacity. This technique is referred to as time division multiple access (TDMA). In regards to interference, an in-band interferer could now affect multiple users that are time sharing this TDMA frequency channel.

Half-duplex

Wireless communication radios typically contain a transmitter and a receiver but in some systems, only one is active at a time. These types of radios are referred to as “half-duplex” and allow for simple, low-cost radio configurations. An example of a half duplex configuration is a push-to-talk (PTT) radio used by emergency service personnel and available as an option on many cellular networks. Data communication devices such as WLAN also use a half-duplex configuration. If the half-duplex radio uses the same frequency channel for both its transmitter and receiver, then an interfering signal would corrupt both links of the communication system.

Full-duplex

Wireless systems that allow the simultaneous transmission and reception of signals, such as found in traditional cellular and military intelligence, surveillance, and reconnaissance (ISR) point-to-point radios, are referred to as “full-duplex” radios. These full-duplex radios typically use separate frequency channels for the transmitter and the receiver. Using the example of a cellular system, communication from the mobile transmitter to the BTS, referred as the uplink or forward link, operates at a different frequency channel than the communication from the BTS to the mobile receiver, referred to as the downlink or return link. The reason to separate the uplink and downlink signals is to prevent the mobile’s own transmit signal from leaking into the mobile’s receiver and appearing as an interference that could not be filtered if the two operated on the same channel.

A specialized filter, called the duplexing filter, can separate two frequency channels and, when placed between the mobile’s transmitter, the receiver and antenna, allows two communication links to occur at the same time. A full-duplex radio system is effectively just two separate communication links occurring in independent frequency channels, transmitting at the same time. In regards to in-band or co-channel interference, the frequency separation between the two communication links would result in an interfering signal affecting only one side of the communication, either as an uplink or a downlink interference.

This information is useful when troubleshooting performance issues in a wireless network. For example, the NA GSM 850 has uplink channels in the frequency band covering 824.2 to 848.8 MHz, and downlink channels from 869.2 to 893.8 MHz. If the system is experiencing problems only on the downlink, the first place to look for interference is over the range of downlink frequencies.

Radio Duplexing (continued)

Example: Duplexing's role in interference identification

Figure 3 shows an over-the-air measurement across a portion of the NA GSM 850 downlink frequency band. The measurement was taken from the Agilent HSA with an omni-directional antenna, commonly called a "rubber ducky" type antenna, attached to the analyzer. The figure displays several of the concepts just mentioned, including subdividing the frequency band into multiple channels and time sharing the spectrum and downlink transmission. Figure 3 shows two active GSM channels centered at 870.0 and 870.4 MHz. The difference between the two channels is that the left channel, centered at 870.0 MHz, is transmitting with data only in a few time slots, while the channel centered at 870.4 MHz, on the right, is transmitting continually with data in all time slots, resulting in a smoother distribution of measured power.

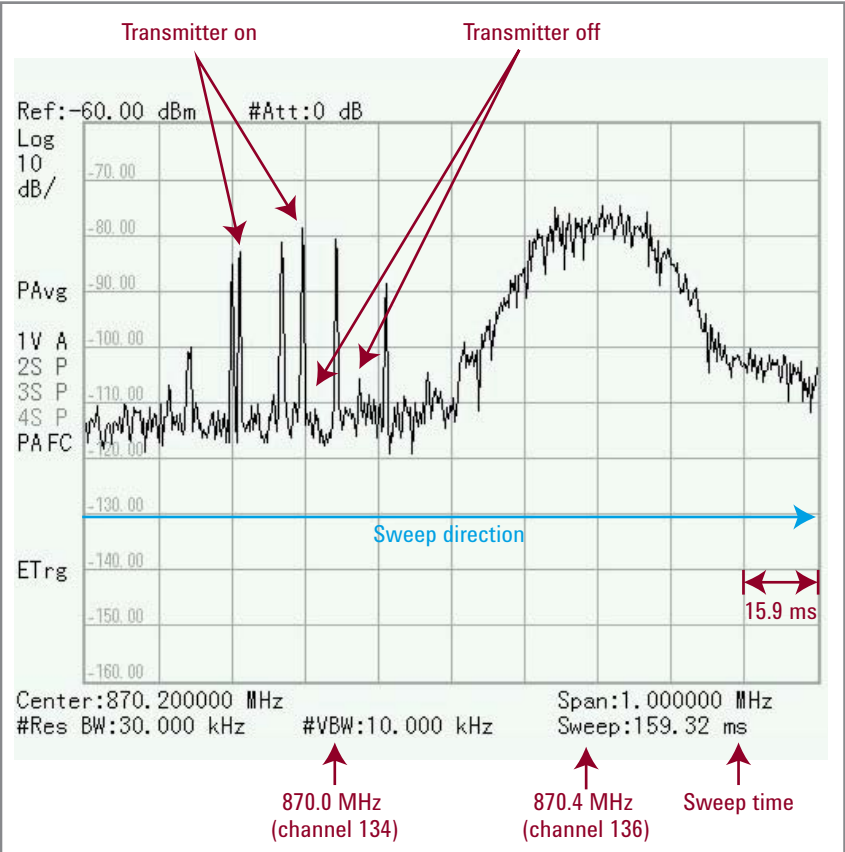

Figure 3. Over-the-air measurement of a GSM 850 downlink transmission using an Agilent HSA with attached antenna

Radio Duplexing (continued)

The reason for the breaks in the measured response for the left channel, centered at 870.0 MHz, is that this radio is not transmitting all the time and the spectrum analyzer is measuring the rapid changes in the signal amplitude as the analyzer sweeps across the display. As the analyzer was configured with a total sweep time of 159.32 milliseconds, each horizontal box is approximately 15.9 milliseconds long. It was previously mentioned that a NA GSM 850 signal has a 4.615 millisecond frame time containing 8 time slots; therefore each box on the analyzer display contains approximately 3.5 frames of user data. As some time slots do not always contain user data, the transmitter is switched off during these empty slots resulting in an uneven spectrum response as the analyzer sweeps.

Later in this application note, there is a discussion on techniques to confirm that the signal has time slots rather than just a series of closely spaced narrowband signals which may have been the first impression when examining the display shown in Figure 3.

Sources of Interference

Interference becomes a problem when a wireless system no longer operates as expected. Even though regulatory agencies and standards organizations define wireless operation and protocols within each frequency band, interference from intentional and unintentional radiators may have detrimental effects on system performance.

Interference from unintentional radiators include:

- electrical equipment
- switching power supplies
- clocks
- control signals
- ignition motors
- other mechanical machinery
- microwave ovens
- other home appliances
- photocopiers
- printers
- fluorescent and plasma lighting
- power lines

late the radio signals propagating in the surrounding environment. Environment conditions such as lightning and precipitation static can degrade system perfor-

Interference from intentional radiators include radio transmissions from other wireless systems such as:

- broadcast radio and television
- cellular
- satellite
- radar
- mobile radio
- cordless phones

It should be noted that the majority of radio interference is generated from other wireless systems operating with faulty transmitters and repeaters or from military combat situation.

Sources of Interference (continued)

Example: Determining the source of interference

As a simple experiment to show the impact of unintentional interference, consider the effect of fluorescent lighting on radio transmission. An RF signal generator was configured to transmit an un-modulated carrier. A spectrum analyzer was used to compare the measured frequency spectrum under two conditions: first with the lighting switched off, and then with the lights switched on.

The signal generator, an Agilent N5182A MXG vector signal generator, was configured to output an un-modulated 915 MHz signal with -10 dBm amplitude. An omni-directional (rubber ducky-type) antenna was attached directly to the signal generator. The spectrum analyzer, an Agilent N9342C HSA, was configured to measure the spectrum around a center frequency of 915 MHz. A second antenna was attached directly to the Agilent HSA and initially the fluorescent lighting was switched off.

Under these conditions, the N9342C HSA has a convenient backlit keypad for instrument control and the instrument screen self-adjusts to a variety of lighting conditions from total darkness to full sunlight (see Figure 4). Figure 5 shows the measurement display from the Agilent N9342C spectrum analyzer when the office lights were turned off.



Figure 4. Backlit keypad and instrument screen make it easy to work in any environment

Sources of Interference (continued)

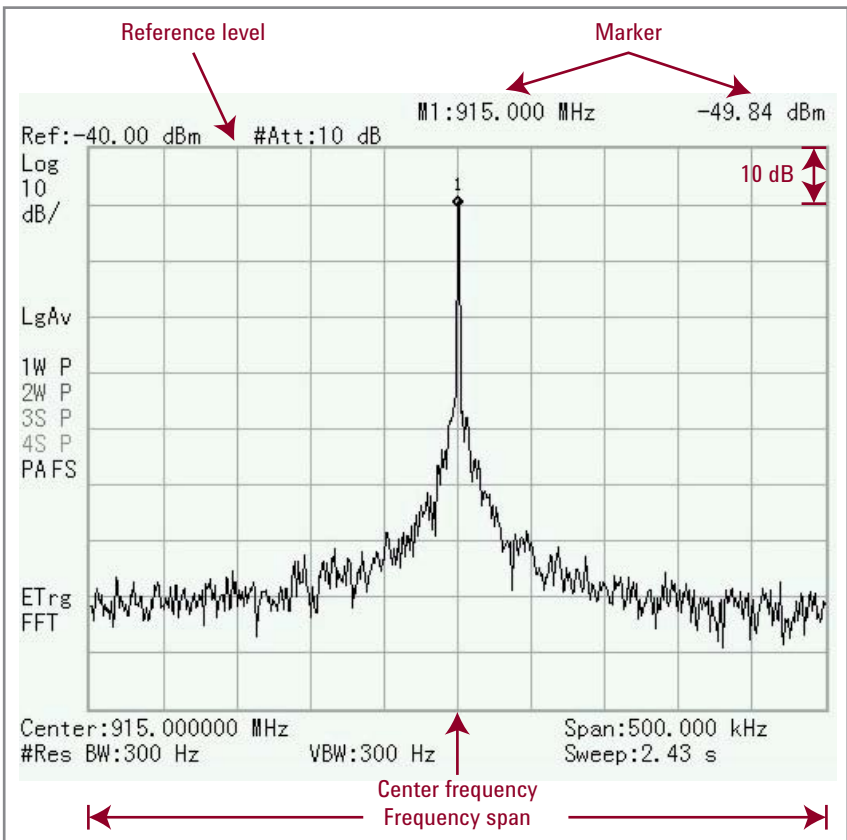

Figure 5. Over-the-air measurement of a 915 MHz RF signal in an office environment with the lighting turned off

Hint:

It is important to properly adjust the reference level so that the signal does not appear to be clipped off the top of the graph.

The analyzer center frequency was set to “915MHz” using the [FREQ] button and the displayed frequency span was set to “500kHz” using the [SPAN] button. The top line of the graph is the reference level and is adjustable using the [AMPTD] button. The reference level is adjusted to optimize the measurement display; in this case, the reference level was set to “-40dBm”. Using the default scaling, each vertical box represents an amplitude difference of 10 dB, shown as “10dB/” on the screen. Therefore with a total of 10 boxes, the bottom line on the graph represents “-140dBm”.

The measured trace in Figure 5 shows a single RF carrier without modulation. The maximum amplitude level and frequency of the signal was measured using a marker placed at the peak of the signal. The marker functions, including “peak search”, are found on the Agilent HSAs but similar functions are available on most commercially-available spectrum analyzers. Using the marker, the peak amplitude is measured to be -49.84 dBm at the expected frequency of 915 MHz. For this measurement, without the fluorescent lights, the spectrum appears relatively clean of any spurious or sideband modulation.

Next, the lights were switched on and the spectrum was measured for a second time. Figure 6 shows the measured spectrum with the fluorescent lighting and now the spectrum includes undesired sidebands modulated onto the RF carrier. This interference has been introduced into the RF signal by the electronic ballast of the fluorescent light fixtures.

Sources of Interference (continued)

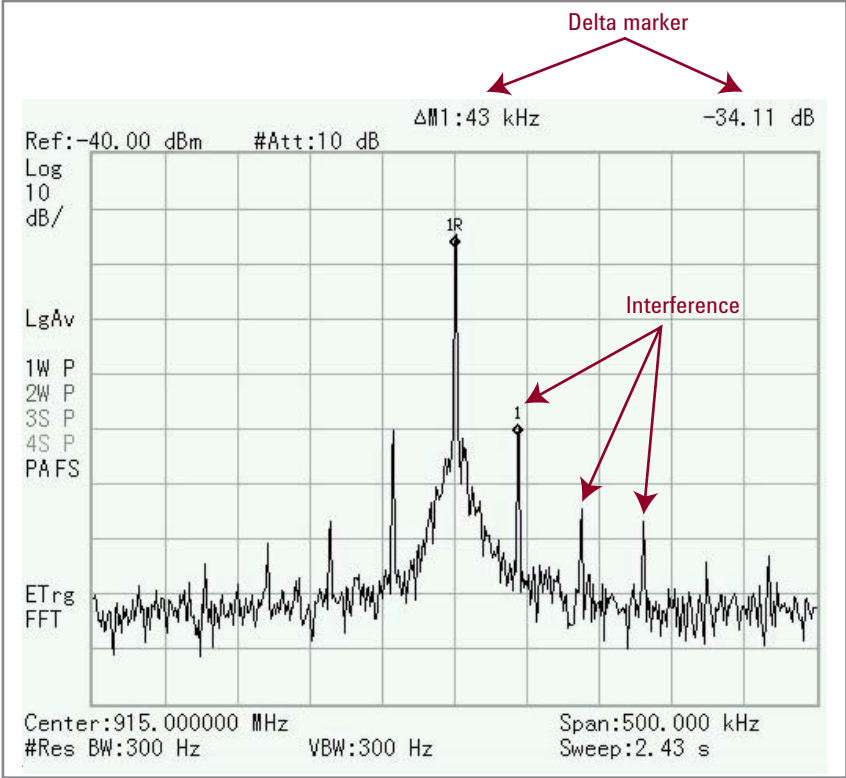

Figure 6. Over-the-air measurement of a 915 MHz RF signal in an office environment with the fluorescent lighting turned on. Shown are the modulation sidebands of the 43 kHz operating frequency of the electronic lighting ballast

Another marker function was used to measure the difference between the peak signal level and the largest interference sideband. The “delta marker” function, also found under the [MARKER] menu, reports a -34.11 dB difference between the peak signal and the largest interference just right of the signal peak. The frequency difference is 43 kHz, which is the operating frequency of the fluorescent lighting ballast. The other interference sidebands are the harmonics of this 43 kHz frequency.

For many wireless systems, these relatively low levels of interference as compared to the signal amplitude would not greatly affect the system performance but to some systems, such as a RFID system using passive UHF RFID tags, this level of interference could have a negative effect on system performance.

Receivers and Spectrum Analyzers

Interference affects a radio system when it enters the receiver and corrupts the detector in the receiver. If the amplitude of the interference is very large, the interference can overpower the receiver's front-end electronics and reduce system performance. Filters are added to the receiver to eliminate interference and noise from entering the system, but any interference that falls within the passband of these filters are combined with the desired signal.

Receiver anatomy

Figure 7 shows a simple block diagram of the four main functions of a receiver: amplification, down-conversion, filtering, and detection.

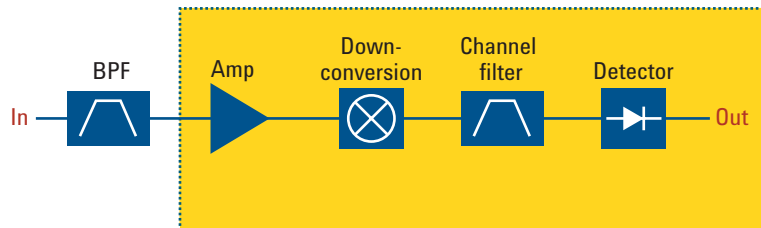

Figure 7. Block diagram of a receiver system. Dotted line represents the components in a typical spectrum analyzer

The bandpass filter (BPF) at the input is set wide enough to allow the entire block of frequency channels to pass while rejecting interference outside the operating frequency range. Amplification in a receiver is required for two reasons: first is that power entering the receiver antenna can be as low as -100 to -120 dBm and amplification is necessary to increase the signal power above the required sensitivity of the detector. Second, the receiver electronics will add noise to the signal as the signal moves along the receive path. By adding a low-noise amplifier near the input, the receiver's signal-to-noise ratio (SNR) can be improved. Amplification is typically spread along the entire receive path but is shown in Figure 7 as a single component for simplicity in the diagram.

The down-converter block function is to tune the system to a specific frequency channel and then translate the high frequency radio signal to a lower frequency in order to ease the process of detection. The lower frequency output from the down-converter is selected to match the center frequency of the channel filter.

The channel filter improves the selectivity of the system by attempting to reject signals in the adjacent channels and beyond. The detector, often referred to as the demodulator, recovers the transmitted data that may include voice, video, or other forms of data.

Spectrum analyzer functionality

The block diagram for a spectrum analyzer is similar to the receiver shown in Figure 7 except that a typical spectrum analyzer does not include the front-end BPF. By removing the BPF, the spectrum analyzer is not limited to a specific band of measurement frequencies and can be configured to continually tune across a broad range of frequencies.

Figure 7 shows a dotted line box around the functions contained in a broadband spectrum analyzer, such as the Agilent N934xC Series or N9340B HSAs which are capable of measuring radio frequencies from 9 kHz to 20 GHz. The detector in a spectrum analyzer converts the energy that passes through the channel filter to a signal that can be displayed on the instrument as the analyzer scans across the frequency range of interest.

Hint:

Care should be taken to guarantee that all signals are safely below the rated damage level before connecting those signals to the HSA.

A few important points to note about a spectrum analyzer are that the equivalent channel filter in the spectrum analyzer is called the resolution bandwidth filter (RBW) and the bandwidth of the RBW can be easily adjusted from the instrument keypad. Also, as the front-end BPF is not included at the input to the analyzer, any signal having large amplitude that enters the instrument could overload or damage the instrument. Therefore, even if the instrument is tuned to measure a narrow range of frequencies, large amplitude signals operating at other frequencies will also enter the instrument and can potentially damage the electronics.

This caution is especially important when measuring the spectrum of nearby transmitters that often have power levels exceeding the input power rating of the instrument. Care should be taken to guarantee that all signals are safely below the rated damage level before connecting those signals to the instrument.

Receivers and Spectrum Analyzers (continued)

Power levels

For example, the high power damage level on the Agilent N9342C HSA is +33 dBm, or 2 watts, for 3 minutes. Measuring signals with power levels above +33 dBm would require the use of an external attenuator or coupler placed at the input to the spectrum analyzer. Also note that the HSA Series analyzers require less than ± 50 volts DC from entering the input, which is typically not a problem when the HSA is connected to an antenna, but could be an issue when connecting to a system that may include DC power along with the radio transmission.

One change to the block diagram shown in Figure 7 that would be typical for a general purpose spectrum analyzer is the addition of a variable attenuator placed before the down-converter. The variable attenuator can be adjusted to optimize the power level entering the down-converter. This may appear counterintuitive as a function of the receiver is to amplify input signals, but since the spectrum analyzer is also used to measure high-power transmitters, the front-end gain is generally not required. The analyzer's attenuator can be manually increased or set to "automatic" to avoid an overload condition. These functions are found under the [AMPTD] menu of the N934xC and N9340B HSAs.

When measuring very low amplitude level signals and interference the variable attenuator should be set to 0 dB to maximize the signal level into the down-converter. In some analyzers, such as the Agilent N934xC and N9340B, the front-end amplifier, or pre-amp, is an option that can be switched in or out to further increase the sensitivity of the instrument. The pre-amp can be manually adjusted or automatically selected when choosing the HiSensitivity feature on the [AMPTD] menu of the N934xC and N9340B HSAs.

Receivers and Spectrum Analyzers (continued)

Example: Properly setting power levels

To provide an example of the proper setting for the power levels entering a spectrum analyzer, Figure 8 shows the measured spectrum of two wideband signals. The main signal centered at 2.42 GHz and the adjacent channel interference is centered at 2.444 GHz. In order for both waveforms to be observed on the same display, the Agilent HSA center frequency was set to the midpoint of 2.432 GHz using the [FREQ] button and the frequency span was set to 60 MHz using the [SPAN].

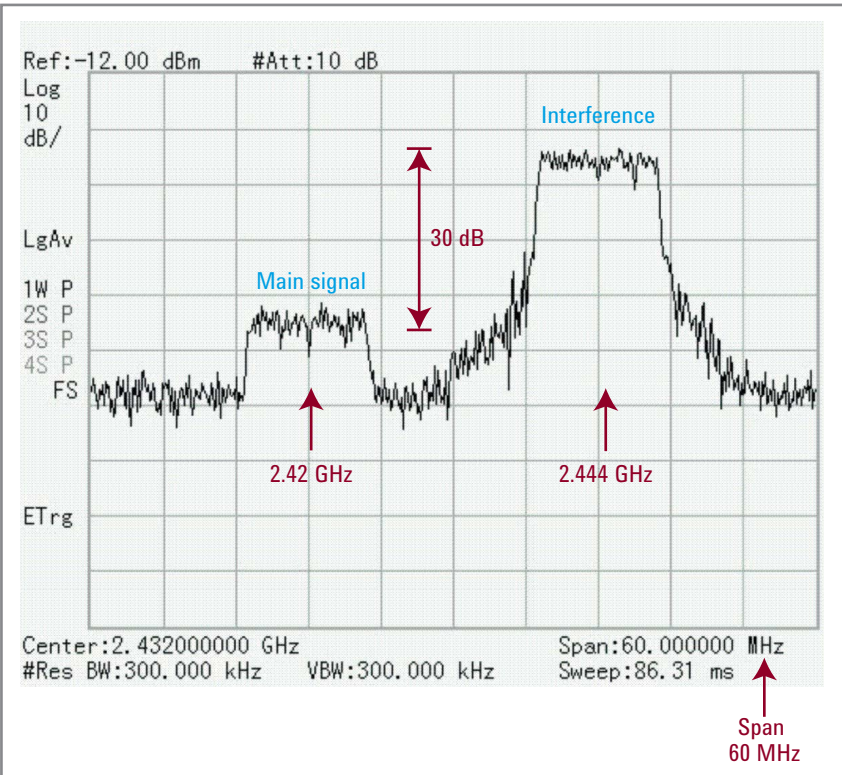

Figure 8. Measurement of two wideband signals with an adjacent channel interference having 30 dB more power than the desired signal. Note that both signals are easily observed using a frequency span of 60 MHz

Knowing that the vertical scaling is set to 10 dB per box it is easy to see that the amplitude of the interference is approximately 30 dB larger than the main signal. As the interfering signal is the larger of two signals entering the input to the analyzer, it would be the power of interference that may overdrive the front-end of the spectrum analyzer.

Figure 9 shows the spectrum of only the main signal using a narrower span of 20 MHz and a center frequency of 2.42 GHz. Even though the interference is not displayed with a 20 MHz span, the interference is still being applied to the input of the analyzer and could overload the front-end of the analyzer. In some applications it may be necessary to place a filter on the input to the spectrum analyzer in order to remove any large amplitude signals that are not part of the measurement but may overload the analyzer's down-converter. It is always the largest signal at the input to the analyzer that sets the top end of the "dynamic range" for the instrument even if the signal is not shown on the instrument display.

Receivers and Spectrum Analyzers (continued)

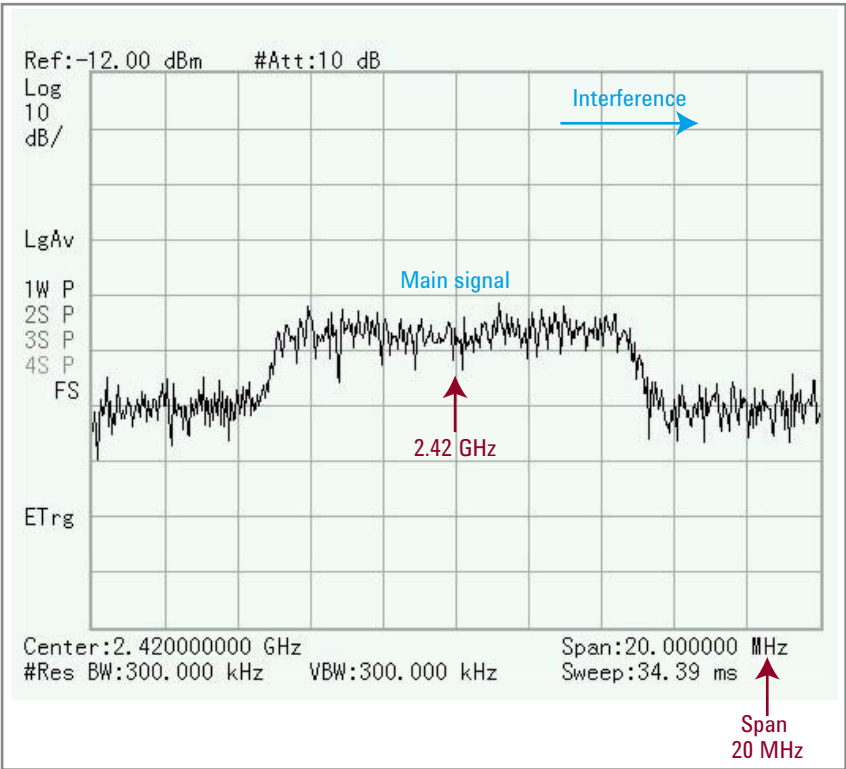

Figure 9. Measurement of a single wideband signal. The adjacent channel interference is still present at the input of the spectrum analyzer but not shown on the display due to the narrow frequency span of 20 MHz

The bottom end of the dynamic range is set by the spectrum analyzer noise floor. A signal will not be observed if the signal's amplitude is below the noise floor of the spectrum analyzer. The noise floor is determined by several factors including the amount of pre-amp gain/attenuation and the RBW filter setting. The pre-amp and attenuator controls can be automatically set using the "HiSensitivity" feature available on the Agilent N934xC and N9340B HSAs. HiSensitivity mode sets the input attenuator to 0 dB, turns on the HSA's internal preamplifier and sets the reference level to -50 dBm. The mode is found under the [AMPTD].

Figure 10 shows an overlay of two measurements with and without the HiSensitivity control. The noise floor of the analyzer is improved by approximately 20 dB when the pre-amp is included in the measurement and the input attenuator is set to 0 dB.

Even without a pre-amp, the noise floor of the analyzer can be optimized using the RBW filter. The RBW filter on the Agilent N934xC HSA is adjusted under the [BW] menu and using the {RBW} setting. Often an automatic setting for RBW will provide a sufficient noise floor on the instrument and manually reducing the RBW will further reduce the observable noise floor.

Figure 11 shows the improvement in the measured noise floor when the RBW is reduced by a factor of ten. For this measurement, the RBW was manually changed from 100 kHz to 10 kHz and the noise floor improved by 10 dB. In this example, the measured peak was the same in both cases, as would be the case for any signal that has bandwidth smaller than the RBW setting. As a result, the

Receivers and Spectrum Analyzers (continued)

Figure 12 shows a similar measurement but with a signal having a much wider bandwidth. Once again, the noise floor dropped by 10 dB as the RBW was changed from 100 kHz to 10 kHz, but as the signal's bandwidth is now wider than the RBW, and therefore appears as noise to the RBW filter, the peak amplitude of the signal also dropped by 10 dB. As a result, the measured SNR does not improve when measuring wide bandwidth signals.

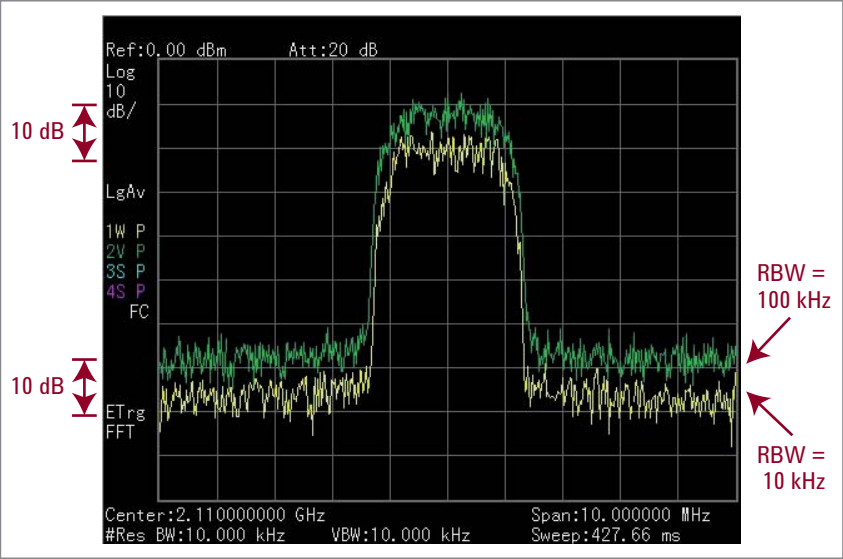

Figure 12. Improvement in the analyzer's noise floor when reducing the RBW setting by a factor of 10. For wide bandwidth signals, the SNR does not improve when the RBW is reduced

Interference Measurement Procedure

Interference measurement procedure

Below is a list of steps that can be used to determine the existence and location of an interfering signal.

1. Report that a reduction in the system performance is observed
2. Confirm the existence of wireless interference using a spectrum analyzer
3. Determine the type of interference by knowing about other wireless signals in the environment
4. Determine the location of the interference using a spectrum analyzer with a directional antenna
5. Correct or remove the source of interference

Once it has been reported that the system is not operating as expected and it is assumed that the root cause of the problem is interference entering the receiver of the system, a spectrum analyzer should be used to confirm the existence of wireless signals in the frequency channel of operation.

The discovery process may involve uncovering the type of signal including duration of transmission, number of occurrences, carrier frequency and bandwidth, and lastly the physical location of the interfering transmitter.

If the system operates in full-duplex mode, then it may be necessary to examine both the forward and reverse link frequency channels for signs of interference. For the spectrum analyzer to measure the same signals and interference that the system receiver is capturing, the spectrum analyzer should be connected into the receive path or directly to the system antenna.

Figure 13A shows a block diagram of a wireless system with the spectrum analyzer connected to a directional coupler placed between the antenna and the transceiver. Many wireless systems, including cellular base stations and radar stations, will have directional couplers installed along the cables connecting the transceiver to the system antenna. As shown in Figure 13A, some directional couplers will have two sample points for monitoring the signals coming from the transmitter or arriving to the receiver. After the spectrum analyzer is connected to the coupler, the signals and interference can be observed during normal system operation.

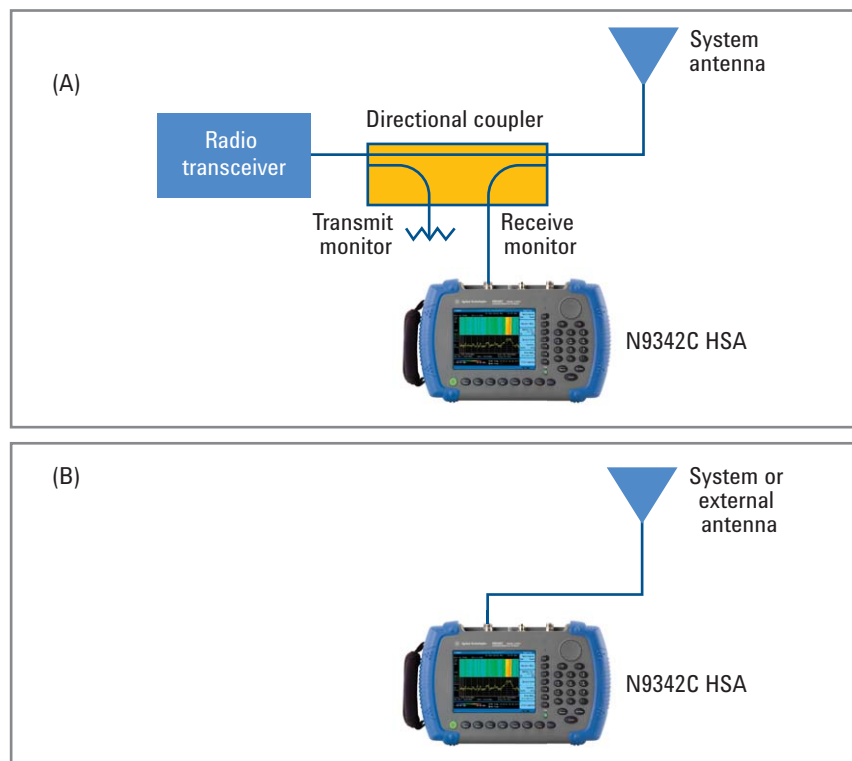

Figure 13. Spectrum analyzer configurations for measuring wireless interference with (A) using a directional coupler and (B) direct connection to the antenna

Interference Measurement Procedure (continued)

For radios that do not provide access between the transceiver and the antenna, the spectrum analyzer can be directly connected to the system antenna or connected to an external antenna with the analyzer placed in the area near the transceiver as shown in Figure 13B. During the discovery process, an omni-directional antenna is a good choice so that signals from all directions are measured from the surrounding environment. Omni-directional type antennas include the rubber-ducky and whip antennas.

If possible, turning off the system transmitter allows the spectrum analyzer to measure in-band and co-channel interference with the lowest noise floor settings as previously discussed. In this case, it is assumed that any nearby out-of-band and adjacent channel transmitters have signal levels low enough so that the spectrum analyzer front-end is not overloaded.

Capturing intermittent signals

Intermittent signals are often the most difficult to measure. The radio performance occasionally suffers from interference at what may seemingly be random times of the day. For cases when the interference is pulsed or intermittent, the spectrum analyzer can be configured to store the maximum trace values over many sweeps. Recalling the over-the-air measurement in Figure 3, the lower channel of the GSM 850 signal was only transmitting during a few time slots resulting in a measured waveform that displayed breaks in the envelope.

Placing the spectrum analyzer in “maximum hold” mode, the instrument will fill in the gaps after several sweeps. The {Max Hold} selection is found under the [TRACE] menu on the Agilent HSAs and the results for the GSM 850 signal using the maximum hold is shown in Figure 14. It is now apparent from Figure 14 that the signals in the two channels have a similar spectrum and power distribution.

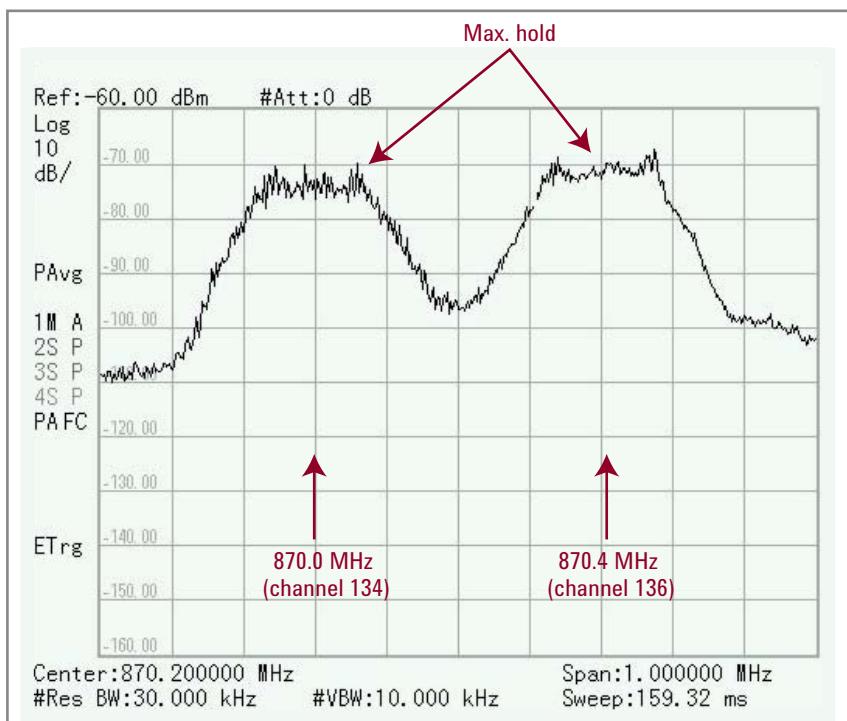

Figure 14. Over-the-air measurement of a GSM 850 downlink transmission using the Agilent N934xC HSA with the trace “Maximum Hold” selected

Interference Measurement Procedure (continued)

The trace option on the Agilent HSAs allows up to four different traces to be displayed. The multiple traces can include combinations of Max Hold, Min Hold, stored memory, and active measurements with different detection options including the default "positive peak". Additional information regarding detection modes can be found in the Agilent application note "8 Hints for Better Spectrum Analysis" (literature number 5965-7009E).

Another useful display option on the Agilent HSA is the spectrogram. A spectrogram is a unique way to examine frequency, time, and amplitude on the same display. The spectrogram shows the progression of the frequency spectrum as a function of time where a color scale represents the amplitude of the signal. In a spectrogram, each frequency trace occupies a single, horizontal line (one pixel high) on the display. Elapsed time is shown on the vertical axis resulting in a display that scrolls upwards as time progresses.

Figure 15 shows a spectrogram of a signal with a transmitter that is intermittently active. In the figure, the red color in the spectrogram represents the frequency content with the highest signal amplitude. The spectrogram may provide an indication to the timing of the interference and how the signal bandwidth may change over time. The spectrogram can be stored to the internal memory of the Agilent HSA or onto an external USB flash drive.

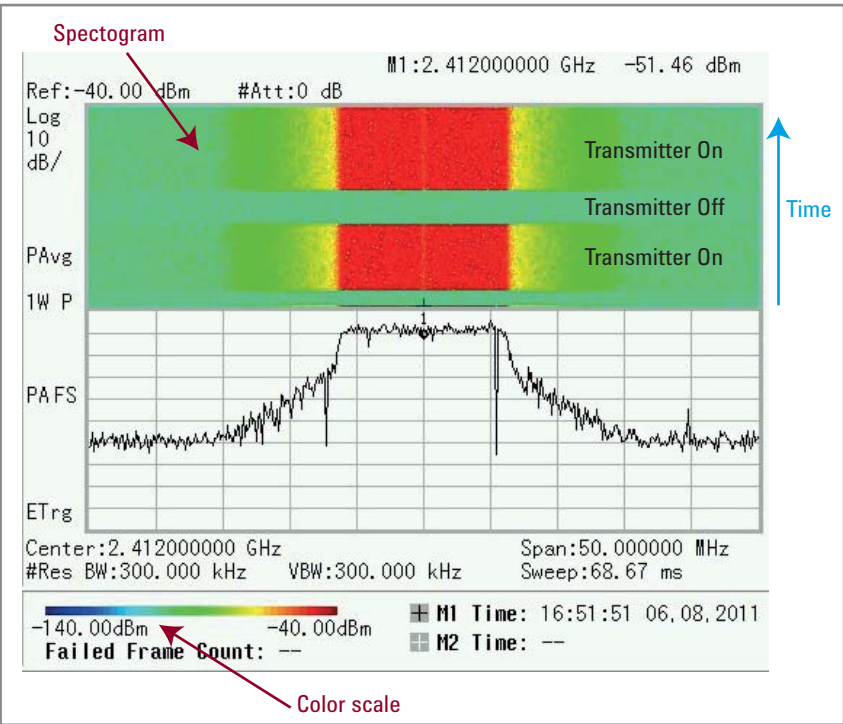

Figure 15. Dual display option showing a spectrogram and the frequency spectrum of a signal with intermittent transmission

Interference Measurement Procedure (continued)

The spectrogram can record 1,500 sets of spectrum data in a single trace file with an update interval that is set by the user. The HSA will automatically create another trace file to save continuously beyond 1,500 sets. For example, on the N9344C HSA sweeping across the full 20 GHz frequency span, the sweep time would be 0.95 seconds. In this case, in one single trace file, the user can set the spectrogram to store data over 48 minutes using an update interval of 1 second or up to 5 days using an update interval of 300 seconds. The spectrogram display is activated using the {SPECTROGRAM} selection under the [MEAS] menu.

Estimating the interferer's location

Once the interference is observed using the spectrum analyzer, understanding the type of signal, such as WIFI, cellular, or other may be helpful in estimating the interferer's location. For example, a wireless equipment operator maintaining a cellular network may observe an "out of spec" transmission from an adjacent frequency channel. Knowing that the type of interference is from another cellular system may provide clues that a nearby repeater may be improperly transmitting energy into the adjacent bands.

Hint:

To make locating the interference source easier, connect a high gain directional antenna, such as a yagi or patch antenna, to the HSA.

The last step in the discovery process is locating the source of the interference. At this point, it is preferred that a directional antenna be connected to the spectrum analyzer since these high gain antennas provide pointing capability within the wireless environment. Directional antenna types include yagi and patch antennas. Antenna gain of 5 dBi or higher is recommended for this application. For example, Agilent's N9311X-508 directional antenna provides a 5 dBi gain over the frequency range of 700 MHz to 8 GHz.

Observing the amplitude of the signal on the spectrum analyzer as the directional antenna is moved around the environment could potentially point to the physical location of the interference when the signal amplitude is at a maximum. Unfortunately multipath reflections in the surrounding environment could reduce the pointing accuracy so it is important to make the measurement from as high as possible such as on rooftops or tall buildings. Cellular base station (BTS) antennas are usually configured with sectorized antennas having a narrow beamwidth and, using a measurement configuration as shown in Figure 13A, may provide an approximate direction (sector) for the interference.

By combining directional measurements from several locations around an environment, it may be possible to triangulate an approximate position for the interfering transmitter. The exact location of the source usually requires driving or walking around a smaller area with the portable spectrum analyzer and directional antenna looking for the maximum signal amplitude. Once the source of the interference is located, the final step is to correct or remove the offending transmitter.

Interference Classifications and Measurement Examples

Interference classifications

- In-band interference
- Co-channel interference
- Out-of-band interference
- Adjacent channel interference
- Uplink interference
- Downlink interference

Interference to radio signals can come from a number of sources including interference created by one's own radio system or by interference created from other radio systems and unintentional radiators such as nearby electrical equipment and mechanical machinery. It was previously mentioned that radio interference can fall into a number of categories and these are explained in this section of the application note along with a few measurement examples.

In-band interference

In-band interference is an undesired transmission from a different communication system or unintentional radiator that falls inside the operating bandwidth of the desired system. This type of interference passes through the receiver's channel filter and if the interference amplitude is large relative to the desired signal, the desired signal will be corrupted.

As previously shown in Figure 1, a different radio system was transmitting directly in the operating channel of the desired system. This figure shows a potential interference located at a center frequency slightly higher than the desired. Figure 6 showed another form of in-band interference created from an unintentional radiator, in this case, the desired RF signal is being modulated by fluorescent lighting. In the cases when the interferer is intentionally attempting to disrupt communications, this in-band interferer would be considered a radio "jammer".

The easiest way to observe in-band radio interference is to turn off the transmitter of the desired radio and use the spectrum analyzer tuned to the channel frequency to look for other signals operating in the channel of interest. For unintentional radiators potentially modulating the desired signal, turn off the offending radiator, such as the lighting in Figure 6. It may be necessary to set the spectrum analyzer to HiSensitivity mode and use the Max Hold display or a spectrogram to record any intermittent signals. HiSensitivity mode sets the input attenuator to 0 dB, turns on the HSA's internal preamplifier and sets the reference level to -50 dBm. The mode is found under [AMPTD], {More (1 of 2)}.

Co-channel interference

This type of interference creates similar conditions as in-band interference except that co-channel interference comes from another radio operating in the same wireless system. In this case, two or more signals are competing for the same frequency spectrum.

For example, cellular base stations will re-use the same frequency channel when the base stations are physically located far apart, but occasionally the energy from one base station will reach a neighboring cell area and potentially disrupt communications. WLAN networks also experience co-channel interference. This is because the WLAN radios listen for an open channel before transmitting and the potential exists for two radios to transmit simultaneously and collide in the same frequency channel.

Interference Classifications and Measurement Examples (continued)

Co-channel interference is one of the most common types of radio interference as system designers attempt to support a large number of wireless users within a small number of available frequency channels.

The easiest way to observe co-channel interference is to turn off the transmitter of the desired radio and use the spectrum analyzer tuned to the channel frequency to look for other signals from the desired system. It may be necessary to set the spectrum analyzer to HiSensitivity mode and use the Max Hold display or a spectrogram to record any intermittent signals.

Out-of-band interference

Out-of-band interference originates from a wireless system designed to transmit in a different frequency band while also producing energy in the frequency band of the desired system. Such is the case when a poorly designed or malfunctioning transmitter creates harmonics that fall into a higher frequency band. Harmonics are multiples (2x, 3x, 4x, etc) of the fundamental carrier transmission.

For example, Figure 16 shows the spectrum of a transmitter designed to operate at 500 MHz. The measurement, taken from the Agilent HSA, shows the fundamental component at 500 MHz and a second harmonic transmitting at 1,000 MHz. This second harmonic signal could potentially interfere with other wireless systems operating near 1,000 MHz.

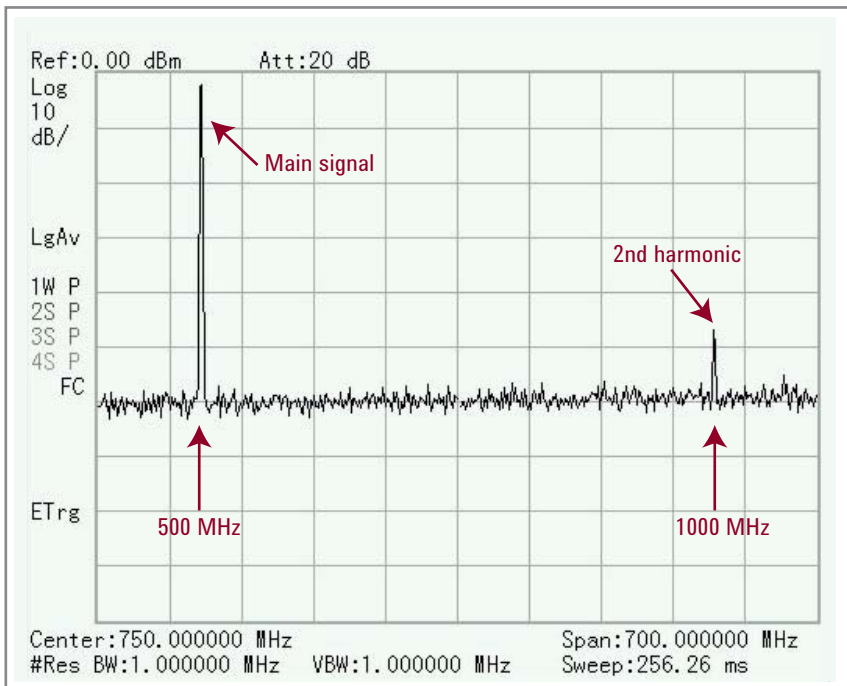

Figure 16. Measurement of 500 MHz unfiltered transmitter showing second harmonic generated at the output

Interference Classifications and Measurement Examples (continued)

It is important, and often a regulatory requirement, to properly filter out the harmonics of a transmitter so that one wireless system does not affect another system operating in a higher frequency band. When examining harmonics of a wireless transmitter, it is necessary to use a spectrum analyzer with a frequency range of at least three times the fundamental operating frequency of the system. For example, when verifying the performance of a transmitter operating at 6 GHz, it may be necessary to measure second and third harmonics at 12 GHz and 18 GHz respectively. In this case, the Agilent N934xC Series includes models with frequency ranges up to 7, 13.6 and 20 GHz.

Hint:

When examining harmonics, use a spectrum analyzer with a frequency range of at least three times the fundamental operating frequency.

Not all out-of-band interference is harmonically related to the fundamental carrier; spurious signals fall into this category. Spurious signals are typically generated in a transmitter resulting from improper shielding of the switching power supplies and clocking signals, or from poorly designed frequency oscillators. Spurious signal interference that fall into the passband of the desired system may have an undesired effect on system performance.

Out-of-band interference may also occur when two or more wireless services operate in the same geographic area and experience a phenomenon called “near-far”. A common form of this interference occurs in a cellular environment when a mobile radio is far from the desired BTS, and very near to a BTS of a competing service provider. Even though both systems operate in different frequency bands, the mobile receives an energy level from the nearest BTS that is much higher than the desired BTS station. The front-end bandpass filter in the mobile will reject most of the energy from the close BTS but some energy will leak through the filter and into the pre-amp/down-converter, potentially corrupting the desired signal due to non-linearities in the receiver’s electronics.

The easiest way to observe out-of-band interference is to turn off the transmitter of the desired radio and first verify the amplitude levels of any signals across a wide frequency range. Next, if all the signals are low relative to the desired signal, tune the spectrum analyzer to the channel frequency and look for other signals within the channel. It may be necessary to set the spectrum analyzer to HiSensitivity mode and use the Max Hold display or a spectrogram to record any intermittent signals.

Interference Classifications and Measurement Examples (continued)

Adjacent channel interference

This interference is the result of a transmission at the desired frequency channel producing unwanted energy in other channels. Adjacent channel interference is common and primarily created by energy splatter out of the assigned frequency channel and into the surrounding upper and lower channels. This energy splatter, often referred to as intermodulation distortion or spectral re-growth, is created in the high-power amplifiers of the radio transmitter due to nonlinear effects in the power electronics.

The details of intermodulation distortion are not included in this application note and additional information can be found in the Agilent product note "Optimizing Dynamic Range for Distortion Measurements" (literature number 5980-3079EN).

As an example of intermodulation distortion, Figure 17 shows a measurement of a digitally modulated signal transmitting on Channel 2. In the figure, Channels 1 (lower) and 3 (upper) represent the adjacent channels relative to this main transmission.

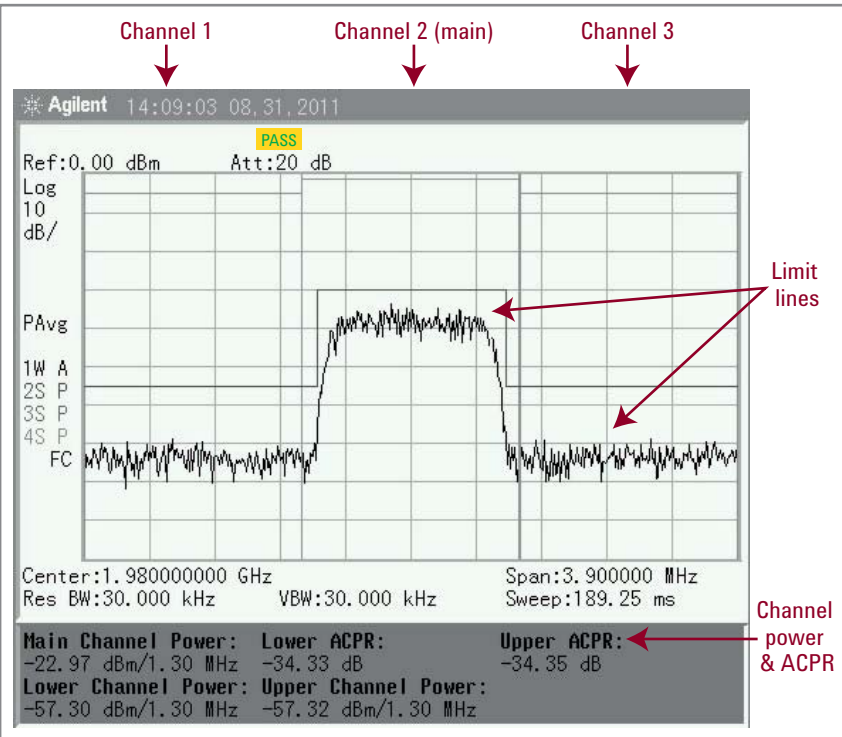

Figure 17. Measurement of adjacent channel power and limit testing

Interference Classifications and Measurement Examples (continued)

The Agilent HSA was configured to automatically measure the power in the main channel and adjacent channels using the adjacent channel power ratio {ACPR} measurement found under the [MEAS] menu. The table under the spectrum display lists the total power, in dBm, for the main channel and the adjacent upper and lower channels. The {ACPR} measurement also reports the power ratio, in dB, between the main channel and each of the two adjacent channels. Limit lines can be placed on the display of the Agilent HSA as a quick check of compliance to the radio specifications. Limit lines are defined under the [LIMIT] menu. Figure 17 shows that the measured spectrum for this transmitter has “passed” the power and frequency requirements across the three channels.

Figure 18 shows a similar measurement but this transmitter has an increase in the adjacent channel power and exceeded the limit line specifications resulting in the “fail” notation to be displayed on the instrument screen. As adjacent channel power measurements are typically made on the transmitter output, it is not necessary to use the HiSensitivity mode on the Agilent HSA. It is important that the transmitter signal level is reduced to a point that the HSA is not overloaded.

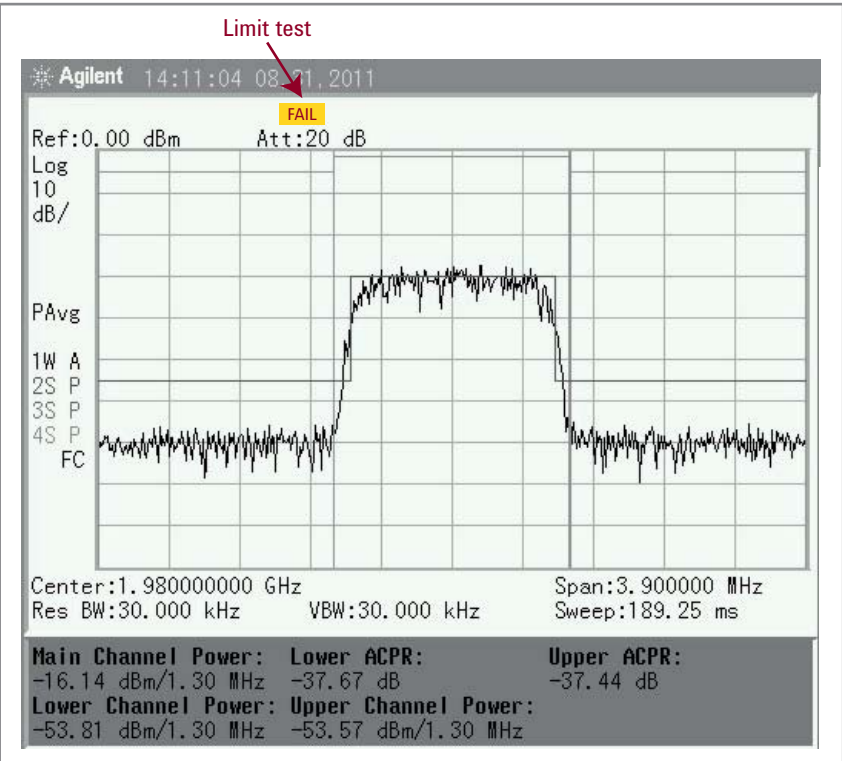

Figure 18. Measurement of adjacent channel power and limit testing showing a out of limit condition

Interference Classifications and Measurement Examples (continued)

Downlink interference

This type of interference corrupts the downlink or forward link communications typically between a BTS and a mobile device. Because of the relatively widely-spaced distribution of mobile devices, downlink interference only impacts a minority of mobile users and has a minimal impact on the communication quality of the system as a whole.

Uplink interference

Also called reverse link interference, uplink interference affects the BTS's receiver and the associated communications from the mobiles to the BTS. Once the BTS is compromised, the cell site's entire service area may experience degraded performance.

Conclusion

This application note has described the techniques and procedures for interference testing in a wireless environment. The classifications for different types of interference including in-band, co-channel, out-of-band, and adjacent channel interference were discussed. Spectrum measurements were made on a variety of wireless signals to show the effectiveness that portable spectrum analyzers, such as the Agilent N934xC and N9340B handheld spectrum analyzers, can have when identifying and locating the source of radio interference.

For More Information

Visit any of the following handheld spectrum analyzer product pages and click on the "Document Library" tab to access additional application notes:

- www.agilent.com/find/n9344c
- www.agilent.com/find/n9343c
- www.agilent.com/find/n9342c
- www.agilent.com/find/n9340b



Agilent Email Updates

www.agilent.com/find/emailupdates

Get the latest information on the products and applications you select.

Agilent Channel Partners

www.agilent.com/find/channelpartners

Get the best of both worlds: Agilent's measurement expertise and product breadth, combined with channel partner convenience.



Agilent Advantage Services is committed to your success throughout your equipment's lifetime. To keep you competitive, we continually invest in tools and processes that speed up calibration and repair and reduce your cost of ownership. You can also use Infoline Web Services to manage equipment and services more effectively. By sharing our measurement and service expertise, we help you create the products that change our world.

www.agilent.com/find/advantageservices



www.agilent.com

www.agilent.com/find/hsa

www.agilent.com/find/hsa-videos

For more information on Agilent Technologies' products, applications or services, please contact your local Agilent office. The complete list is available at:

www.agilent.com/find/contactus

Americas

Canada	(877) 894 4414
Brazil	(11) 4197 3500
Mexico	01800 5064 800
United States	(800) 829 4444

Asia Pacific

Australia	1 800 629 485
China	800 810 0189
Hong Kong	800 938 693
India	1 800 112 929
Japan	0120 (421) 345
Korea	080 769 0800
Malaysia	1 800 888 848
Singapore	1 800 375 8100
Taiwan	0800 047 866
Other AP Countries	(65) 375 8100

Europe & Middle East

Belgium	32 (0) 2 404 93 40
Denmark	45 70 13 15 15
Finland	358 (0) 10 855 2100
France	0825 010 700*
	*0.125 €/minute
Germany	49 (0) 7031 464 6333
Ireland	1890 924 204
Israel	972-3-9288-504/544
Italy	39 02 92 60 8484
Netherlands	31 (0) 20 547 2111
Spain	34 (91) 631 3300
Sweden	0200-88 22 55
United Kingdom	44 (0) 131 452 0200

For other unlisted countries:

www.agilent.com/find/contactus

Revised: June 8, 2011

Product specifications and descriptions in this document subject to change without notice.

© Agilent Technologies, Inc. 2011
Published in USA, October 11, 2011
5990-9074EN



Agilent Technologies