

Keysight Technologies

Techniques for Precise Measurement Calibrations in the Field

Using FieldFox handheld analyzers

Application Note

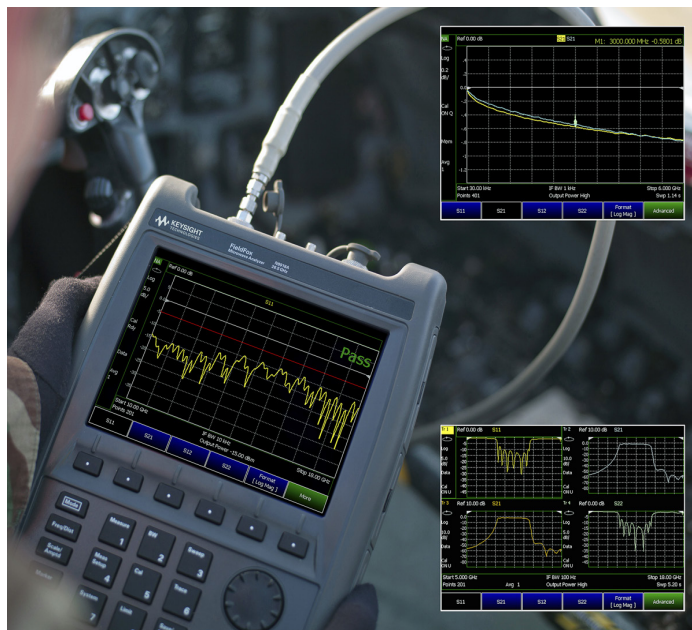

This application note, which applies to cable and antenna and vector network analysis, discusses recent advances in vector network analyzer calibration and compares measurements using different calibration types for a variety of RF and microwave devices including cables, filters and amplifiers. A FieldFox handheld analyzer is used to make the various measurements, as it can perform precise measurements and analysis in the field.

Introduction

Installation, troubleshooting and maintenance of RF and microwave systems and components require measurements of their reflection and transmission characteristics within a variety of indoor and outdoor environments and conditions. These measurements are typically made using a handheld vector network analyzer (VNA) having a user calibration that is preformed in the field. Measurement accuracy, calibration convenience, sweep speed and analyzer portability are extremely important requirements as testing often occurs under extreme conditions ranging from high elevations, such as outdoor tower and mast installations, to confined spaces, required in shipboard, aircraft and vehicle applications. The required measurements are easily obtained using a VNA with a simple user calibration and fast measurement sweep, which are available on FieldFox handheld analyzers.

Measurement accuracy when using a VNA is directly related to the type of user calibration selected and the associated test configuration. The test configuration includes test cables and adapters required to interface the Device Under Test (DUT) to the VNA. The types of calibrations available on FieldFox range from the built-in calibration (CalReady), which is available immediately at instrument turn-on, to more complex user calibrations requiring measurements from a set of high-quality calibration standards.

Selection of the calibration type (cal type) is often a trade-off between measurement accuracy, speed and the complexity of the calibration process. For example, Figure 1 shows a comparison of the measured insertion loss (S21) of a short coaxial cable using two different cal types available on FieldFox. The yellow trace is the cable measurement using an innovative cal type named QuickCal and the blue trace is the measurement of the same cable using a traditional Full 2-Port mechanical calibration. The Full 2-Port calibration process requires that the user make seven connections to various high-quality calibration standards while QuickCal was performed without the need for any calibration standards. As shown in the figure, there is very little difference between the two measurement results yet the QuickCal has a fairly simple calibration process that is very convenient in field operations. In general, as each test configuration may require the use of adapters and test cables between FieldFox and the DUT, it is important to understand the applications and limitations of each cal type available in FieldFox. This application note will discuss recent advances in VNA calibration and will compare measurements using different calibration types for a variety of RF and microwave devices including cables, filters and amplifiers.

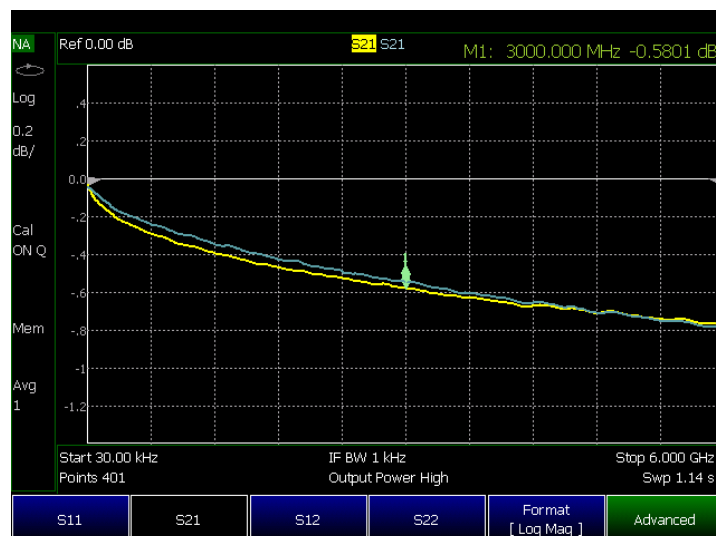

Figure 1. Measurement comparison of a coaxial cable using a traditional Full 2-port calibration (blue) and the rapid QuickCal (yellow) available on a FieldFox vector network analyzer

Analyzer Hardware Configurations

This section of the application note will introduce the various FieldFox hardware configurations available for measuring one-port and two-port devices. FieldFox handheld analyzers include vector network analyzers (VNA), cable and antenna test (CAT) analyzers, spectrum analyzers, and combination analyzers that include VNA, CAT and spectrum analyzer capabilities in one instrument. FieldFox is a field-ready, precision instrument compliant with MIL-PRF-28800F Class 2, and MIL-STD-810G, Method 511.5, Procedure 1, for operation in explosive environments (type tested). Class 2 equipment is designed for the most rugged environments which include unprotected and uncontrolled environmental conditions. Configured as a VNA, FieldFox measures complex device parameters, namely the magnitude and phase of reflection and transmission characteristics of one-port and two-port DUTs. The measured complex parameters are also known as scattering parameters (S-parameters) and will be reviewed later in this application note. Configured as a CAT analyzer, FieldFox also measures the reflection and transmission characteristics of a DUT but only reports the magnitude characteristics. Both the VNA and CAT modes include the innovative QuickCal that remove the effects of any test cables and adapters attached to the instrument and also corrects for drift errors in the calibration caused by temperature changes. Configured as a spectrum analyzer, FieldFox is a high-performance receiver capable of measuring the frequency content of known and unknown signals, interference and/or noise. FieldFox spectrum analyzers not only have capabilities found in benchtop spectrum analyzers, but also include a unique feature known as InstAlign that provides improved amplitude accuracy across the entire RF and microwave frequency range from turn-on and through $-10\text{ }^{\circ}\text{C}$ to $+55\text{ }^{\circ}\text{C}$. This application note will continue with the primary focus on VNA measurement and calibration using the FieldFox VNA while additional information regarding the CAT and spectrum analyzer modes can be found in Keysight Technologies, Inc. application notes [1] and [2].

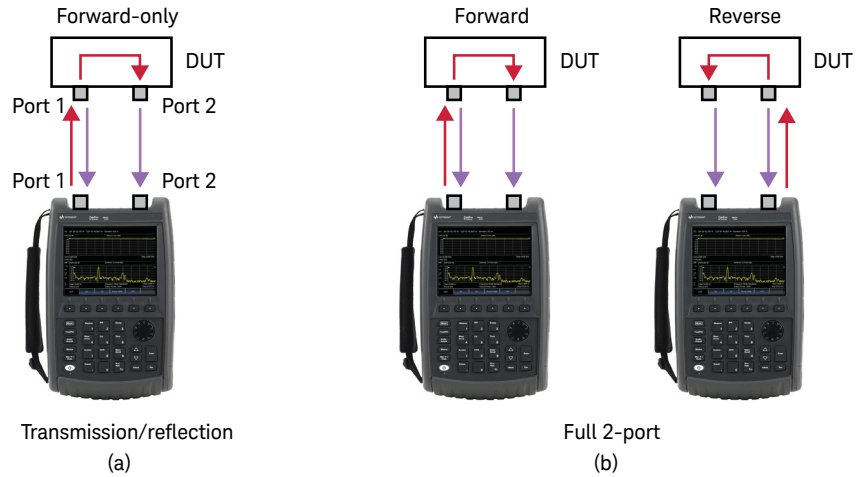

Figure 2. Network analyzer signal paths when measuring a device under test (DUT) using an analyzer with (a) Transmission/Reflection (T/R) hardware and (b) Full 2-Port hardware

The network analyzer hardware determines how the DUT is measured, either in the forward direction only, using a transmission/reflection (T/R) hardware configuration, or in both the forward and reverse directions using a Full 2-Port configuration. Figure 2a shows the signal paths to and from the FieldFox VNA having a T/R hardware configuration. With a T/R configuration, the test signal leaves Port 1 of the analyzer and measurements are made only in the forward direction, either as reflection from the input to the DUT or as transmission through the DUT. With this configuration, the reflected signals are measured at Port 1 of the analyzer and forward signal transmission is measured at Port 2 of the analyzer. When using a T/R configuration, measurements in the reverse direction would require that the DUT be disconnected, turned around, and re-connected. In contrast, Figure 2b shows a VNA configured with Full 2-Port hardware. In this arrangement, the DUT parameters can be measured in the forward and reverse directions without the need to physically turn the device around. A switching matrix within the analyzer internally routes the incident test signal between Port 1 and Port 2. In addition to the convenience of measuring the DUT in both directions, using a Full 2-Port configuration can provide the

highest level of measurement accuracy by allowing the characterization and removal of most of the systematic errors from the test system.

Characterization of systematic errors is performed during the user calibration and the Full 2-Port calibration is one of the most accurate methods of VNA calibration. This application note will discuss and compare several cal types including Full 2-Port, Enhanced Response and the less accurate but very simple Response (Normalization) calibrations. A FieldFox VNA with Full 2-Port hardware can perform all available cal types. FieldFox with T/R hardware can only perform Enhanced Response and Response (Normalization) calibrations.

Systematic Errors

Systematic errors are created by the frequency response of the test cables, adapters and analyzer components, the leakage paths typically internal to the analyzer, and by multiple reflections between the DUT and the analyzer. As part of the user calibration, systematic errors are characterized and mathematically removed from the measurements. Some types of user calibrations only correct a subset of the errors, resulting in reduced accuracy in the measurement of the DUT. Figure 3 shows a comparison of the transmission response (S_{21}) through a coaxial cable using a Full 2-Port calibration (yellow) and an Enhanced Response calibration (blue). The Full 2-Port calibration reports the highest measurement accuracy as this cal type corrects most systematic errors in the test system. Removal of all systematic errors using a Full 2-Port cal requires sweeps in the forward and reverse directions, both during calibration and during DUT measurement. The calibration and DUT measurement using the Enhanced Response cal

type requires only one sweep direction, either forward or reverse, and therefore will result in an overall faster measurement. The Enhanced Response cal does not correct for all systematic errors and will therefore be less accurate than the Full 2-Port calibration. As shown in Figure 3, the cable measurement using the Enhanced Response cal shows ripples across the measured frequency range as a result of the uncorrected systematic errors. Both measurements shown in Figure 3 use the innovative CalReady calibration found on the FieldFox analyzers. CalReady is a built-in, always available calibration that does not require a manual user calibration. This application note will discuss CalReady and the other cal types available in the FieldFox VNA and the tradeoffs between accuracy, speed and calibration complexity. Additional information regarding systematic errors and basic VNA calibration theory can be found in the Keysight Application Note, Network Analyzer Basics [3].



Figure 3. Measurement comparison of a coaxial cable using the FieldFox CalReady 2-Port calibration and the CalReady Enhanced Response calibration

S-Parameter Measurements and Display Formats

It was previously mentioned that a VNA is typically configured to measure and display the reflected and transmission properties of a DUT also known as scattering parameters (S-parameters). S-parameters are simply ratios of the measured signal to the incident signal. The FieldFox VNA contains all the appropriate hardware to measure and calculate these signal ratios so the operator only needs to be familiar with the S-parameter definitions and how they relate to specific device specifications. Figure 4 shows the S-parameter definitions for a two-port DUT. A one-port device will have one S-parameter and a two-port device will have four S-parameters. Determination of which DUT port is considered Port 1 or Port 2 is decided by the user and often has a relationship to the intended operation for the DUT. For example, an amplifier would be defined with the input as Port 1 and the output as Port 2. In this way, the amplifier's forward transmission parameter would be the gain when moving from Port 1 to Port 2. Examining Figure 4, the S11 parameter is defined as the reflection from Port 1 of the DUT. The S22 parameter is defined as the reflection from Port 2 of the DUT. S21 is the forward transmission parameter going from Port 1 to Port 2. S12 is the reverse transmission parameter.

For many passive devices, including coaxial cables, filters, waveguide components, couplers and power dividers, the forward transmission, S21, is equal to the reverse transmission, S12, in other words, $S_{21} = S_{12}$. This type of DUT is considered "reciprocal." Amplifiers, circulators, and most active devices that include semiconductors and ferrites are "non-reciprocal." The forward transmission of a non-reciprocal device, such as the gain of an amplifier, is not equal to the reverse transmission, such as the reverse isolation of an amplifier ($S_{21} \neq S_{12}$). Knowledge of whether a device is considered reciprocal or non-reciprocal will become important when selecting the Enhanced Response calibration that will be discussed later in this application note. The forward

reflection, S11, and the reverse reflection, S22, are generally not equal under all device types. Figure 5 shows the four S-parameters for a 13-GHz band pass filter measured on a FieldFox VNA with a Full 2-Port configuration. As mentioned, the Full 2-Port configuration allows all four S-parameters to be measured with one connection to the analyzer. The S11 and S22 reflection parameters have a slightly different response across the measured frequency range of 5 to 18 GHz. The S21 and S12 have an equal response which is expected for a reciprocal device such as a passive filter. For the measurement shown in Figure 5, FieldFox was calibrated using the most accurate cal type, the Full 2-Port calibration. The four S-parameter measurements shown in Figure 5 are all displayed using the typical format of "LogMag" with the y-axis shown in decibels (dB). The measured S-parameters

using a VNA are complex values that can be converted to a variety of display formats including linear magnitude, VSWR, Smith chart, polar, phase, group delay, and real and imaginary. Fortunately, FieldFox manages all necessary calculations and properly displays the desired format(s).

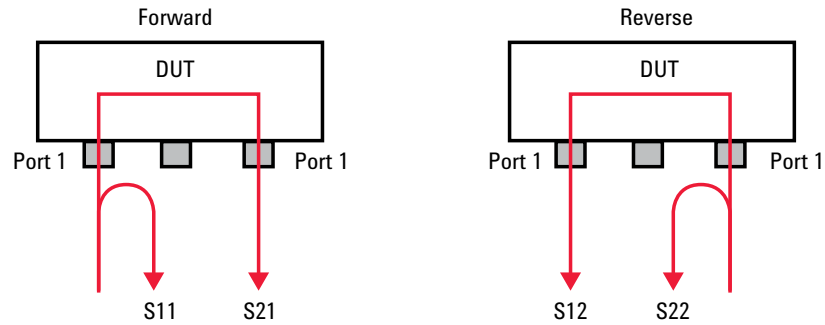

Figure 4. S-parameter definitions for a 2-port device under test (DUT)

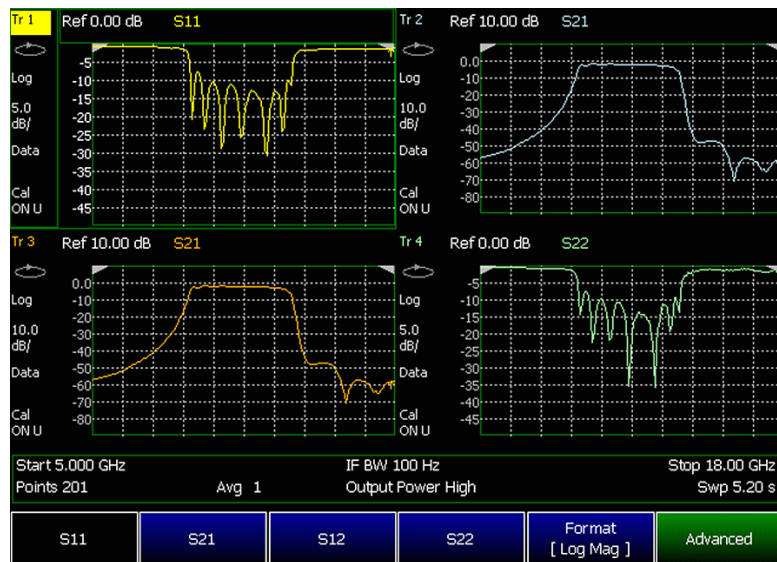

Figure 5. Measured S-parameters for a 13-GHz band pass filter

S-Parameter Measurements and Display Formats (continued)

Knowing that S-parameters are relative measurements, they are theoretically independent of the applied power level. For example, when measuring S₁₁ of an ideal short circuited transmission line, the ratio of the reflected signal to the incident signal has a linear magnitude of 1, or 0 dB ($=20\text{LOG}(|S_{11}|)$). This measured value of S₁₁ from the shorted line is the same whether the incident signal power is 1 picowatt or 100 watts. This condition is true for S-parameter measurements of passive devices. Obviously, when measuring amplifiers, the S-parameters will be dependent on the incident power once the amplifier begins to enter saturation. For this application note, it is assumed that amplifiers will be operating in their small signal or non-saturated mode and the gain is then constant over a range of incident power levels.

When measuring amplifiers and other devices sensitive to input power level, FieldFox test port power can be adjusted to optimize the measurement accuracy and avoid overload conditions in the active device and the analyzer. The FieldFox VNA has three modes for setting the incident (test port) power level—High Output Power, Low Output Power, and setting that allows the operator to manually set the test port power. FieldFox default setting at High Output Power will achieve the highest measurement accuracy and dynamic range, while Low Power or manual setting will be a good choice when measuring high gain amplifiers or any device sensitive to drive power. Figure 6 is a measurement example showing the relationship between test port power and displayed dynamic range.



Figure 6. Measurement comparison of a 13-GHz band pass filter response using the High Output Power setting (yellow) and the Low Output Power setting (blue) on FieldFox

This figure shows a comparison of the measured S₂₁ of a 13-GHz band pass filter using the High Output Power setting (yellow trace) and the Low Output Power setting (blue trace). Within the center pass band of this filter, the S₂₁ measurements are identical but when using the Low Power setting, the noise level is noticeably higher in the rejection bands. The higher noise floor is the result of the poor signal-to-noise conditions at the FieldFox receivers as the filter reduces the signal level in the rejection bands. Under low SNR conditions, the IF BW on FieldFox can be reduced to improve the analyzer's noise floor. The IF BW can be adjusted over a range of 10 Hz to 100 kHz. The highest dynamic range and accuracy will

be achieved with the High Output Power setting and a minimum value in IF BW setting. Additional information regarding optimizing the test port power and the IF BW can be found in the FieldFox User's Guide. Additional information regarding S-parameters and network analyzer theory can be found in the following Keysight reference [3].

Calibrating FieldFox Test Ports

FieldFox offers a choice of user calibrations that can remove the effects of test cables and adapters that may be placed between the VNA and the device under test. As previously mentioned, the user calibration will also correct for systematic errors in the VNA. These types of user calibrations are performed by the operator on a regular basis and are independent of the general instrument calibration that may be required on a yearly cycle. The yearly instrument calibration is a traceable process that is performed by a certified test lab, such as Keysight, and confirms that the instrument is performing to its stated specifications. The yearly instrument calibration should be traceable to International System (SI) units through a national metrology institute such as NIST, NPL or BIPM. With a fully traceable instrument calibration, FieldFox is capable of making highly accurate measurements at the test ports. In practice, different test requirements may result in a variety of test cables and adapters being connected to FieldFox. It is often preferred that the effects of these cables and adapters not be included in the measurement. In this case, FieldFox allows a user calibration to be performed, with or without a calibration kit, in order to establish the calibration plane beyond the test cables and adapters. Operators familiar with the operation of VNAs will be familiar with some of these types of user calibrations. The next few sections of this application note will review the different cal types available on FieldFox.

There are several types of user calibrations available for accurately measuring the S-parameters of components and systems. Several cal types have been briefly mentioned above including CalReady, QuickCal and Mechanical. The Mechanical cal type is a traditional VNA calibration requiring the use of a high-quality calibration kit. The innovative Cal-

Ready and QuickCal do not require such a kit. In general, for all cal types, any additional test cables and adapters should be phase-stable, high-quality items and maintained in very good condition to improve the accuracy and repeatability in the measured data.

CalReady

The easiest calibration to implement on FieldFox is CalReady. The CalReady cal type requires no action by the user and is available immediately upon instrument power-on or instrument preset. This built-in calibration is performed at the factory over the full frequency range of FieldFox and is applied directly to the test ports of FieldFox as shown in Figure 7a. CalReady has the highest measurement accuracy when the DUT is connected directly to the test ports on FieldFox. As shown in Figure 7b, CalReady is ideally suited for measuring the performance of a coaxial cable when the cable can be connected directly between Port 1 and Port 2 of

FieldFox. It should be noted that FieldFox test ports are configured with Type-N female connectors or 3.5 mm male connectors (for microwave 26.5 GHz models), therefore the electrical characteristics of any adapters connected between the cable and FieldFox will be included as part of the measurement. Figure 7c shows a typical configuration for testing a two-port DUT requiring a short test cable and two adapters to make connection to FieldFox. As the calibration plane is at the test ports of FieldFox, the test cable and adapters will be included as part of the S-parameter measurements. There are other cal types, including QuickCal and Mechanical Cal, which can remove the effects of these test components and will be discussed in the later sections of this application note.

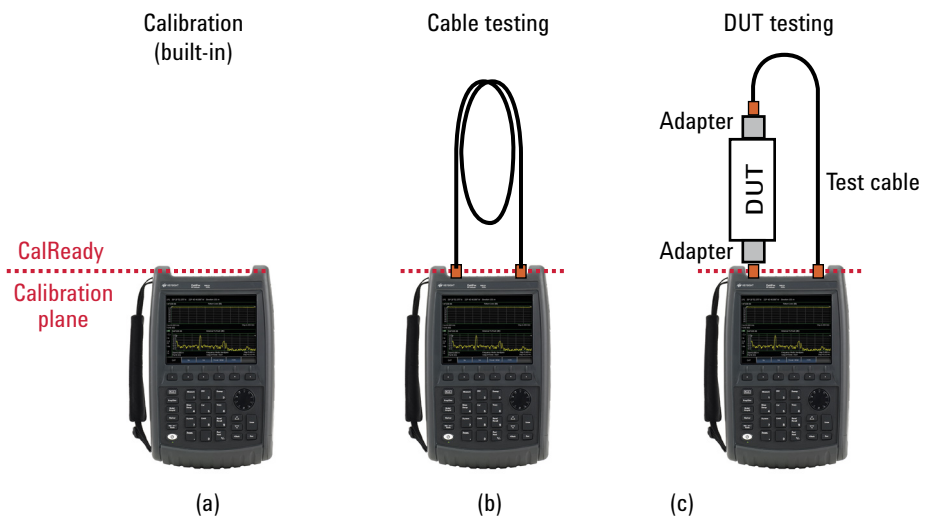

Figure 7. Calibration and test configurations using FieldFox CalReady

Calibrating FieldFox Test Ports (continued)

CalReady (continued)

CalReady can be configured as a Full 2-Port calibration or as an Enhanced Response calibration. As previously shown in Figure 3, CalReady and other Full 2-Port cal types achieve the highest measurement accuracy by measuring the DUT in both the forward and reverse directions and removing all systematic errors from the measured S-parameters. CalReady using the built-in Enhanced Response calibration requires only a single measurement sweep, either forward or reverse, and therefore will improve the overall measurement time compared to the Full 2-Port version. The disadvantage of the Enhanced Response cal is lower accuracy as only a subset of the systematic errors is corrected. The Enhanced Response cal type is the default cal type when FieldFox is powered ON or preset.

Under certain circumstances, the measurement accuracy using the Enhanced Response cal can be improved when the DUT is a reciprocal device and having FieldFox configured for a Reciprocal Enhanced Response cal type. As previously mentioned, a reciprocal DUT will have equal forward and reverse transmission parameters, namely $S_{21} = S_{12}$, which is typical for all passive devices such as cables, adapters, couplers and filters. Figure 8 shows a measurement comparison using CalReady configured with Enhanced Response cal and CalReady configured with a Full 2-Port cal. The DUT is a short coaxial cable connected directly to FieldFox test ports and the measurement is S11. The upper (yellow) trace shows the response using the Enhanced Response with a Nonreciprocal definition for the DUT. The lower (yellow) trace shows the measurement using Enhanced Response with a Reciprocal definition for the DUT. The lower (blue) trace shows the measurement using the Full 2-Port calibration. From this figure, it appears that the Enhanced Response cal

with Reciprocal definition shows a measurement almost identical to that using the Full 2-Port calibration. The Enhanced Response with Nonreciprocal definition is not as accurate. It should be noted that selecting a Reciprocal definition for a DUT that is actually nonreciprocal (amplifier) will result in incorrect measurements. In contrast, selecting a Nonreciprocal definition for a reciprocal DUT will result in correct measurements but with lower accuracy as shown in Figure 8. When in doubt, it is always safe to leave the default setting for Nonreciprocal. To summarize, the calibration terms for CalReady Enhanced Response and CalReady Full

2-Port are characterized at the factory and stored internally to the FieldFox. The Nonreciprocal and Reciprocal definitions are mathematical techniques that handle the process for correcting systematic error in the instrument. Table 1 shows a comparison of the relative accuracy and measurement times using the Enhanced Response and Full 2-Port cal types. The table is valid for CalReady and other Mechanical calibration types using Enhanced Response and Full 2-Port calibrations.

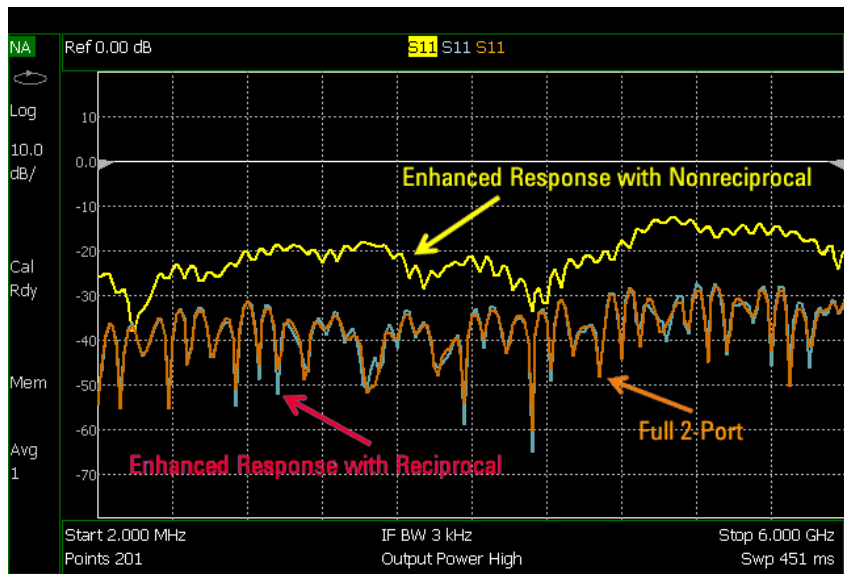

Figure 8. Measurement comparison of the S11 for a coaxial cable using the Full 2-Port cal type and the Enhanced Response cal types (reciprocal and nonreciprocal definitions for the DUT)

Table 1. Comparison of the relative accuracy and measurement times using the CalReady Enhanced Response and CalReady Full 2-Port calibration types.

CalReady Cal type	Accuracy	Measurement time
Enhanced Response - Nonreciprocal	Good	Best
Enhanced Response - Reciprocal (requires DUT with $S_{21}=S_{12}$)	Better	Best
Full 2-Port	Best	Good

Calibrating FieldFox Test Ports (continued)

QuickCal

Often the test configuration requires the addition of test cables and adapters to connect the VNA to the DUT, similar to the configuration previously shown in Figure 7c. In order to remove the effects of test cables and adapters from the measurement, FieldFox must be calibrated by the user to establish the calibration plane away from the VNA and at the connection to the DUT. User calibration often requires a “calibration kit” that includes a set of high-quality coaxial or waveguide standards that are measured by the VNA during the calibration process. FieldFox includes an innovative user calibration technology called QuickCal which does not require a calibration kit. QuickCal provides accurate S-parameter measurements by adapting the built-in CalReady calibration terms in order to remove systematic errors associated with test cables and adapters connected to FieldFox test ports. QuickCal may also be used to correct for drift errors caused by temperature changes in the instrument, test cables and adapter. Correcting for temperature changes is very important in field operations when environmental conditions can change rapidly as measurements are made both indoors and out. QuickCal does not support attenuators and nonreciprocal devices in the signal path between the instrument test port and calibration plane.

QuickCal is a simple two-step process requiring a measurement sweep of the open-ended test cables or adapters and a measurement sweep of a THRU connection. This two-step process is required for two-port measurements. One-port measurements require only one step, the open-ended sweep. No calibration standards are required when performing a QuickCal. Figure 9a shows a diagram of the two step process for performing a QuickCal on FieldFox. As shown in this figure, the first step is to leave the end of any adapters and/or test cables open. An OPEN calibration standard is not required as found in a mechanical calibration. The second step in the QuickCal process requires direct connection of the two test ports which may or may not require an adapter for this THRU connection. The adapter characteristics are not required as part of the calibration and in some cases the adapter can be the DUT itself. More information on the requirements for the “Unknown THRU” will be provided in the next section of this application note. It is important to note that the test cables and adapters be high-quality phase-stable components otherwise the calibration

may not be accurate and/or stable. Once the two-step QuickCal process is complete, the DUT can be measured without including the effects of any test cables and adapters. Figure 9b shows a typical connection diagram when testing a two-port DUT. As the calibration plane is now moved to the DUT plane, the test cable and adapters are removed from the S-parameter measurements. It should be noted that if the DUT has an expected S_{11} or S_{22} less than -15 dB, an optional LOAD standard may be measured during the QuickCal process to improve the accuracy of the DUT measurements. Ideally the LOAD standard should have the same connector type as the DUT and does not need to be a “calibration kit” load standard. The LOAD can be any termination with a reasonably good return loss to improve the accuracy of the measurement.

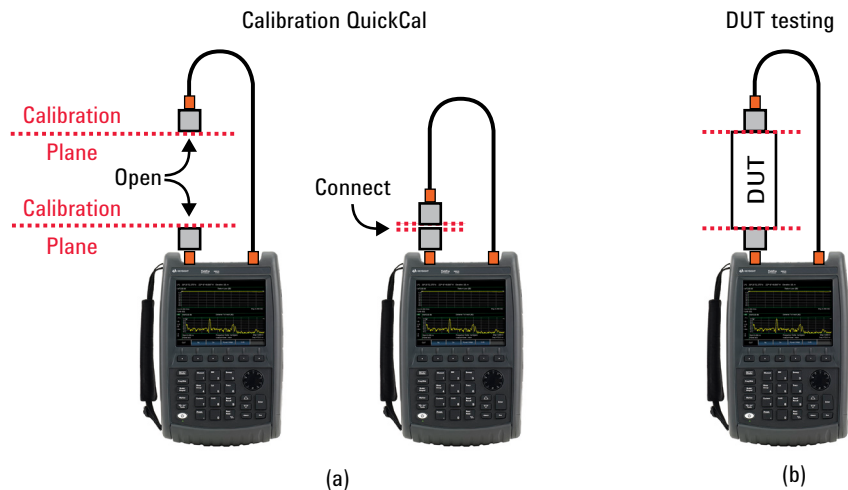

Figure 9. Test configuration for (a) QuickCal calibration for rapid calibration of FieldFox VNA and associated test cable and adapters and (b) DUT connection for measurements at the QuickCal calibration plane

Calibrating FieldFox Test Ports (continued)

QuickCal (continued)

QuickCal can be performed using options for one-port and two-port DUTs. A DUT with only one port requires a calibration and measurement of S11, or S22. The QuickCal process for one-port devices only requires the open measurement sweep, and possibly the optional LOAD for higher accuracy. QuickCal for two-port DUTs follows the same procedure discussed above but can be selected as a Full 2-Port calibration or an Enhanced Response calibration. The recommended option is the more accurate Full 2-Port but when faster measurements are required, the Enhanced Response option can be selected. As mentioned, the Enhanced Response calibration only requires measurements in the forward or reverse direction. Full 2-Port calibration requires measurements in the forward and reverse direction making the measurement sweep time longer in comparison.

Figure 10 shows a comparison of the S21 measurement of a band pass filter using CalReady and QuickCal cal types. Both calibrations are using the Full 2-Port cal type. The filter measurement using the CalReady shows a lower dB value for S21 as the insertion loss of the test cable was included as part of the filter measurement (similar to the configuration shown in Figure 7c). In this case, the additional loss of the test cable makes the filter appear to have a higher insertion loss than it actually does. The filter measurement using QuickCal shows the proper insertion loss measurement as the insertion loss of the test cable is removed from the measurement (similar to the configuration shown in Figure 9b).

Calibrating insertable devices

A two-port DUT can be categorized as an "insertable" device or a "non-insertable" device. An insertable device will have connectors of the same type but different gender, such as a DUT having a Type-N male connector on DUT Port 1 and a Type-N female connector on DUT Port 2.

In this case, FieldFox, and associated test cable(s), would also have test ports with the opposite gender connectors allowing the DUT to be directly connected to FieldFox without any adapters. This configuration also allows FieldFox test ports to be directly connected during the THRU step in the calibration process. Figure 11 shows the configurations for calibrating and testing an insertable device with Type-N connectors. Figure 11a shows the location of the calibration plane using a FieldFox VNA and a single test cable having Type-N connectors with opposite genders. The calibration planes are at the locations where QuickCal will require the open-ended connectors. When selecting

a mechanical calibration, the calibration plane is at the location where the cal kit standards are connected, typically the same place as would be used for the QuickCal. For either cal type, the THRU connection does not require an adapter and the calibration plane is ideally established at the DUT ports. Figure 11b shows the connection of the insertable DUT to the FieldFox test setup.

On FieldFox analyzers, QSOFT is the recommended 2-port calibration algorithm for insertable devices. It requires only four connections (a 1-port cal and a thru measurement) and provides very good accuracy.

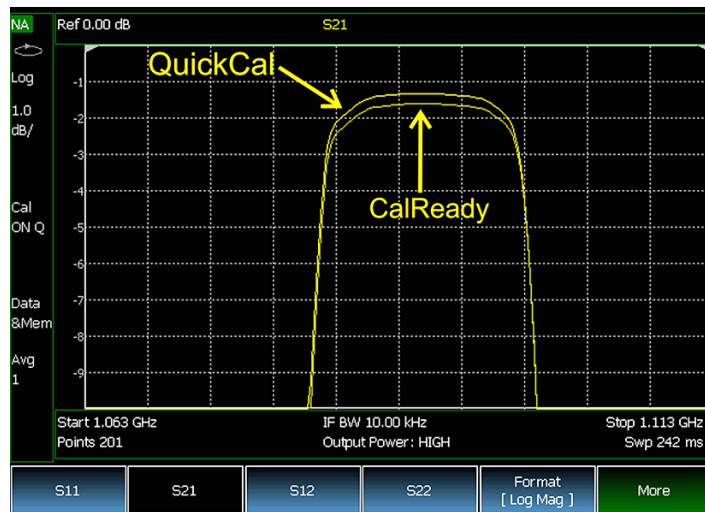

Figure 10. S21 Measurement comparison of a band pass filter using CalReady and QuickCal calibration types

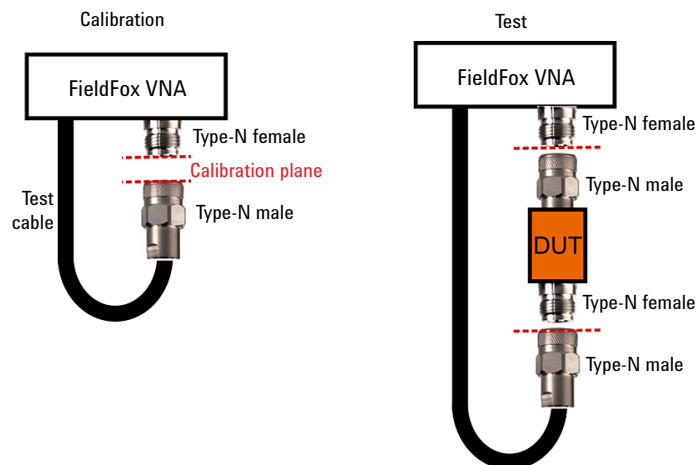

Figure 11. (a) Calibration and (b) measurement configurations for measuring an "insertable" device

Calibrating FieldFox Test Ports (continued)

Calibrating non-insertable devices using unknown thru A non-insertable device has connectors of the same type and same gender or connectors with different types, such as coax on one port and waveguide on the other (QuickCal does not support waveguide connectors at this time).

The Full 2-Port calibration process for a non-insertable device requires the addition of an adapter during the THRU step in the process. Ideally, the adapter should have the same connector type and gender as the DUT. Traditionally, when measuring non-insertable devices using a VNA, the electrical delay of the THRU adapter in a Full 2-Port calibration needed to be accurately defined or a complex calibration process was required using multiple calibrations [3]. Fortunately, FieldFox VNA offers the “Unknown THRU” calibration and any cable or adapter can be used to connect the test ports together during this step in the cal process. The Unknown THRU is available in QuickCal and Full 2-Port cal types. The Unknown THRU can be any device that has the same connector configuration as the DUT. The Unknown THRU may also have a long electrical length such as a long length of coaxial cable. The Unknown THRU can also be the DUT itself as long as the insertion loss is less than 40 dB across the measured frequency range and the DUT is a reciprocal device. Figure 12a shows the configuration for calibrating the FieldFox VNA using an Unknown THRU. In this example, the adapter has Type-N female connectors on both ports to match the connectors on the non-insertable DUT. FieldFox is available with Type-N female connectors, therefore, in this example, test cables and adapters must be used to convert FieldFox test ports to Type-N male connector types. As shown in the figure, the calibration planes are established at the ends of the Type-N male in

the QuickCal or by the cal kit standards in a mechanical calibration. After the Unknown THRU calibration is complete, the non-insertable DUT can be accurately measured without the effects of the THRU adapter. As a measurement example, Figure 13 shows a VSWR measurement of a waveguide-to-coaxial adapter. As this non-insertable DUT has different connector types, a Full 2-Port calibration with Unknown THRU will provide the highest measurement accuracy. In this example, a Keysight X281C with Option

012 X-band coaxial waveguide adapter, shown in the figure, was measured over the frequency range of 7 to 13.8 GHz. The Full 2-Port calibration was implemented using Type-N and waveguide mechanical calibration standards.

During the calibration process, the DUT was inserted as the Unknown THRU. FieldFox can support X-band, P-band and K-band calibration kits. More information regarding waveguide bands and flange designations can be found at [4].

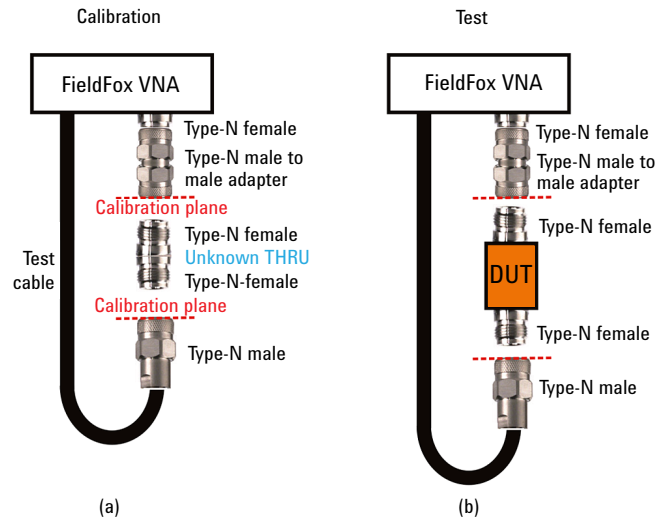

Figure 12. Example test configuration for calibrating the analyzer and measuring a "non-insertable" device using an Unknown THRU

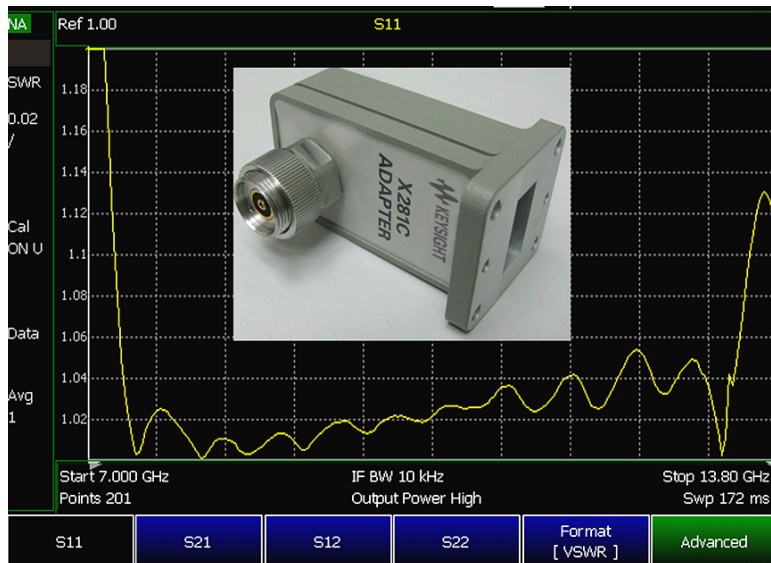

Figure 13. Measured VSWR of an X-band coaxial waveguide adapter using the adapter as the Unknown THRU

Mechanical Calibration

When implementing a calibration on FieldFox, the main advantage of using CalReady and QuickCal is that a calibration kit is not required. This makes calibrating the instrument in the field a fairly simple and rapid process. When the highest level of measurement accuracy is required, a traditional Mechanical calibration is the recommended cal type. The Mechanical calibration is performed using discrete calibration standards contained in a high-quality cal kit. The cal kit standards have well-defined characteristics, and measurements of these standards allow the VNA to mathematically determine the systematic errors in the test system that includes the analyzer, test cable(s) and adapters. Cal kits are available from Keysight in a range of connector families, including Type-N (50 ohm and 75 ohm), 7/16, 3.5 mm, Type F, 7 mm, TNC and several waveguide kits including X-band, P-band and K-band.

The standards in a cal kit typically include an Open, Short and Load (O, S, L). The O, S, L definitions are unique to each connector family and gender. The definitions are built into FieldFox and the connector type and gender are selected for each test port during a guided calibration process. Based on the selected S-parameters and the DUT connector configuration, FieldFox offers a recommendation for a cal type that is optimized for speed and accuracy. The user has the option to change the cal type based on a preference for higher accuracy or faster measurement time. Table 2 lists the types of mechanical calibrations available on FieldFox. The table also summarizes the relative accuracy and calibration speed for each type. Measurement speed is also related to the calibration speed as some measurements require only forward or reverse sweeps, such as Enhanced Response and Normalization and some measurements require both forward and reverse sweeps, such as Full 2-Port and QSOLT.

Full 2-port calibration

The most comprehensive Mechanical calibration is the Full 2-Port cal. Figure 14a shows the steps required to calibrate FieldFox using a traditional Full 2-Port cal type requiring Open, Short and Load standards attached to each test port. As shown in the figure, the first step in the Full 2-Port calibration process requires six connections, three standards at each test port. A single sweep, either forward or reverse, is made for each one of these standards. The second step is the THRU where the two test ports are connected together. A forward and reverse sweep is required for the THRU. After these seven connections, the calibration is complete and the calibration plane is set at the end of the test ports. Figure 14b shows the configuration for measuring the DUT as connected to the two test ports. FieldFox

includes two innovative techniques for improving the accuracy and calibration speed of the mechanical Full 2-Port calibration. The first technique was already discussed, namely the application of the Unknown THRU during the mechanical calibration. As previously shown, the Unknown THRU greatly reduces the complexity when calibrating for non-insertable DUTs. The second technique is the Full 2-Port QSOLT. QSOLT is quicker to perform than a traditional Full 2-Port calibration while still maintaining the high level of accuracy. QSOLT reduces the number of steps when measuring cal kit standards as QSOLT does not require measurement of the O, S, L standards at test port 2. The only requirement for QSOLT is that test port cables mate together without the use of an adapter, or in other words, the DUT must be insertable.

Table 2. Comparison of the relative accuracy and calibration times using Mechanical calibration types available on the FieldFox VNA

Cal type	Accuracy	Calibration speed
Full 2-Port	Best	Poor
QSOLT Full 2-Port	Best	Better
Enhanced Response	Good	Best
Response (Normalization)	Poor	Best
1-Port (for 1-port DUT only)	Best	Better

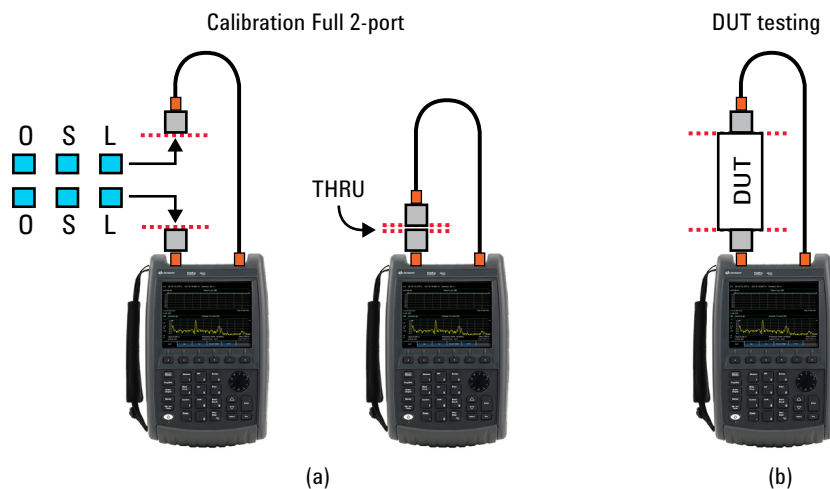

Figure 14. Test configuration for (a) the Full 2-Port calibration requiring Open, Short and Load (O, S, L) calibration standards and (b) DUT connection for measurements at the calibration plane

Mechanical Calibration (continued)

Full 2-port calibration (continued)

Figure 15a shows the steps required to calibrate FieldFox using a Full 2-Port QSOLT cal type. As shown in the figure, the first step in the QSOLT calibration process is three connections of the Open, Short and Load standards to test port 1. A single sweep is made for each one of these standards. The second step is the THRU where the two test ports are directly connected together; no adapters can be used for this cal type. A forward and reverse sweep is required for the THRU. The calibration plane for test port 2 is established after the THRU is measured. After these steps, the calibration is complete and the calibration plane is set at the end of the test ports with the similar measurement accuracy as the traditional Full 2-Port calibration. Figure 15b shows the configuration for measuring the DUT as connected to the two test ports. Measurements of the DUT require forward and reverse sweeps in order to completely remove all systematic errors from the measured S-parameters.

Enhanced response calibration

When lower measurement accuracy is acceptable and faster measurement time is desired, the Enhanced Response mechanical calibration is a good choice for measuring either the forward response (S11, S21) or the reverse response (S12, S22). The Enhanced Response mechanical cal type is similar in function to the CalReady version previously discussed with the exception that the mechanical cal requires the measurement of O, S, L cal standards. While the CalReady version places the calibration plane at the FieldFox connectors, the Enhanced Response mechanical cal places the calibration plane at the interface to the DUT resulting in higher measurement accuracy. The calibration process for the Enhanced Response is identical to the QSOLT as shown in Figure 15a. The main difference when using the Enhanced Response is that the calibration and measurements only occur in one direction, either forward or reverse. The Enhanced Response will result in faster measurement times but

not having measurements in two directions will result in uncorrected systematic errors thus reducing the overall measurement accuracy.

The Enhanced Response cal type is selected using either the Forward Enhanced Response or the Reverse Enhanced Response. As the name suggests, the forward cal type only provides S11 and S21 measurements while the reverse type only provides S12 and S22 measurements. It is important to note that the option for Nonreciprocal and Reciprocal devices is still valid for this mechanical cal type. These options were previously discussed in the CalReady section of this application note. Figure 16 shows a measurement

comparison of the gain from a broadband 2 to 18 GHz low-noise amplifier using the QSOLT cal type, shown in the upper trace (yellow), and the Forward Enhanced Response cal type, shown in the lower trace (blue). While the mechanical calibration procedures are almost identical for these two cal types, the gain response using the Enhanced Response has far more ripple in measured response as the result of uncorrected systematic errors. The measurement related to the Enhanced Response cal shown in Figure 16 required the option for Nonreciprocal as the DUT was an amplifier. For this amplifier test, the test port output power was manually reduced to -35 dBm to prevent the amplifier from saturating.

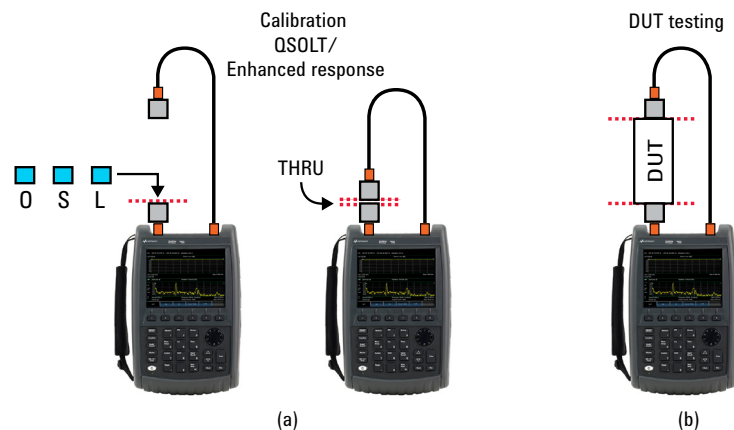

Figure 15. Test configuration for (a) the Full 2-Port QSOLT and the Forward Enhanced Response calibrations requiring Open, Short and Load (O, S, L) calibration standards and (b) DUT connection for measurements at the calibration plane

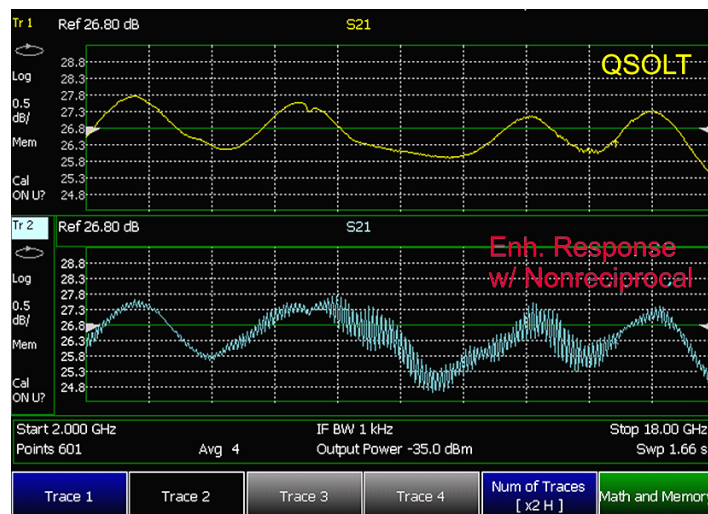

Figure 16. Measurement comparison of the gain for a broadband 2 to 18 GHz low-noise amplifier using Full 2-Port QSOLT cal type (upper trace) and Enhanced Response cal type with nonreciprocal definition (lower trace)

Mechanical Calibration (continued)

1-Port OSL and response (normalization) calibrations

The 1-Port OSL cal is used for reflection-only measurements of one-port DUTs. A one-port DUT can be an antenna, termination or detector to name a few. The 1-Port OSL cal type can be applied to either test port 1 or test port 2 of the VNA and will provide the highest measurement accuracy when measuring a one-port DUT. The 1-Port OSL mechanical calibration procedure requires the measurement of the Open, Short and Load standards at the selected test port.

Response or Normalization calibration is simple to perform but only corrects a minor subset of the systematic errors in the test system and therefore, the accuracy is very low. Response calibration is essentially a normalized measurement where a reference trace is stored in memory, and subsequent measurement data is divided by this memory trace. This type of calibration is good for a quick check of the operation of a DUT and where measurement accuracy is not a consideration. In most cases, it will be better to just use the built-in CalReady calibration.

Calibration Wizard

The FieldFox is a highly-capable microwave VNA that provides accurate user calibration without the need for a calibration kit, when using the CalReady and QuickCal cal types. As discussed, FieldFox also provides a selection of Mechanical cal types when a calibration kit is available for field use. Whether calibrating with QuickCal or a Mechanical cal type, FieldFox provides step-by-step instructions for performing a user calibration with a built-in guided calibration process called the “Calibration (Cal) Wizard.” The Cal Wizard displays the standard type and associated port connection for each step in the process. For example, when calibrating the FieldFox with QuickCal for a S11 measurement, the first step is to leave Port 1 open and

the next (optional) step is to connect the Load. At each step, the user is instructed to press the “Measure” key to perform a measurement sweep of the standard. When all standards are measured, the Cal Wizard applies the error correction and returns the instrument display to the measurements screen.

Depending on selected S-parameters and DUT connector types, the Cal Wizard recommends a calibration type that will provide rapid calibration and high measurement accuracy. For example, if FieldFox is configured to measure a single S-parameter such as S11 and a Mechanical calibration is selected, the Cal Wizard recommends a 1-Port OSL calibration and will guide the user to connect the Open, Short and Load cal kit standards to Port 1 of the VNA. There is also the option to select a different cal type where a more experienced user may change from the recommendation based on a specific measurement need and level of accuracy. For example, Figure 17a shows the Cal Wizard display for selecting the type of mechanical calibration. Here, the Cal Wizard has recommended the Full 2-Port cal type but the user may also select any cal type from the list including Enhanced Response and QSOLT.

As previously mentioned, it is important for the user calibration that the DUT connector type is properly entered for the test configuration. Entering the DUT connector(s) and associated gender(s) allows the Cal Wizard to make the best cal type recommendation and ensures that the VNA will use the appropriate connector models in the error correction process. Figure 17b shows the Cal Wizard display for entering the connector type and gender for each test port. In this example, the DUT is a single-port device having a 3.5 mm male connector type. As part of the Cal Wizard instructions, the calibration kit model number is also selected.

Cal Wizard is an ideal guide for both novice and experienced users by providing detailed instructions, connection diagrams and flexibility which help improve the accuracy and speed of the analyzer calibration. The Cal Wizard is part of the VNA and CAT measurement modes on all RF and microwave models of FieldFox.

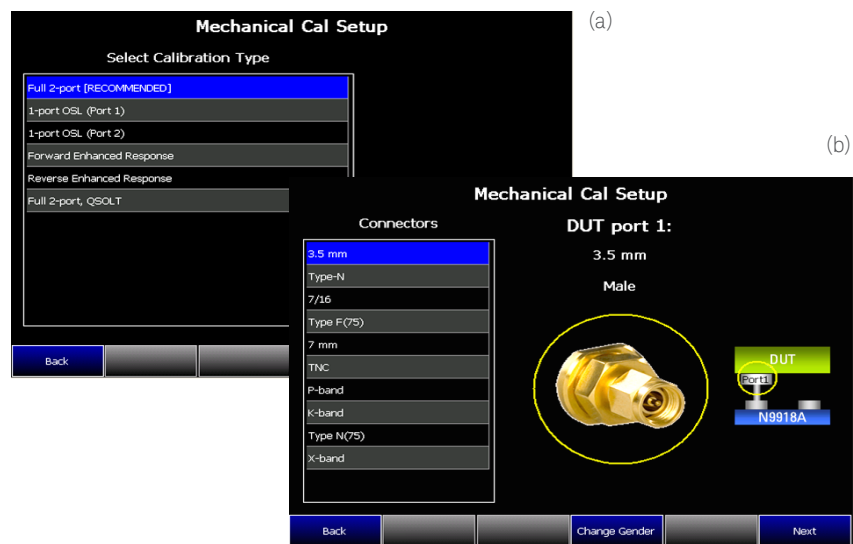

Figure 17. FieldFox Calibration (Cal) Wizard display screens showing (a) selecting the calibration type and (b) selecting the DUT connector type

Conclusion

This application note has introduced recent advances in vector network analyzer calibration using FieldFox. It was shown that FieldFox CalReady and QuickCal calibration types provide high measurement accuracy while eliminating the need to carry a calibration kit into the field. Calibration procedures and measurement comparisons were examined for many of the calibration options available on FieldFox.



FieldFox handheld analyzers deliver benchtop-instrument accuracy in field-test environments with MIL-spec durability in satellite communications, microwave backhaul, military communications, radar systems and a wide range of additional applications.

References

- [1] *Techniques for Precise Interference Measurements in the Field*, Application Note, Literature number 5991-0418EN.
- [2] *Techniques for Precise Cable and Antenna Measurements in the Field*, Application Note, Literature number 5991-0419EN.
- [3] *Keysight Network Analyzer Basics*, Literature Number 5965-7917E.
- [4] *Keysight RF & Microwave Test Accessories*, Waveguide Accessories, Flyer.

Carry Precision With You.

Every piece of gear in your field kit had to prove its worth. Measuring up and earning a spot is the driving idea behind Keysight's FieldFox analyzers. They're equipped to handle routine maintenance, in-depth troubleshooting and anything in between. Better yet, FieldFox delivers Keysight-quality measurements—wherever you need to go. Add FieldFox to your kit and carry precision with you.

Related literature	Number
FieldFox Combination Analyzers, Technical Overview	5990-9780EN
FieldFox Microwave Spectrum Analyzers, Technical Overview	5990-9782EN
FieldFox Microwave Vector Network Analyzers, Technical Overview	5990-9781EN
FieldFox Handheld Analyzers, Data Sheet	5990-9783EN
FieldFox Handheld Analyzer, Configuration Guide	5990-9836EN
FieldFox N9912A RF Analyzer, Technical Overview	5989-8618EN
FieldFox N9912A RF Analyzer, Data Sheet	N9912-90006
FieldFox N9923A RF Vector Network Analyzer, Technical Overview	5990-5087EN
FieldFox N9923A RF Vector Network Analyzer, Data Sheet	5990-5363EN

Download additional application notes, watch videos, and learn more:
www.keysight.com/find/FieldFox

myKeysight

myKeysight

www.keysight.com/find/mykeysight

A personalized view into the information most relevant to you.

Three-Year Warranty

www.keysight.com/find/ThreeYearWarranty

Keysight's commitment to superior product quality and lower total cost of ownership. The only test and measurement company with three-year warranty standard on all instruments, worldwide.



Keysight Assurance Plans

www.keysight.com/find/AssurancePlans

Up to five years of protection and no budgetary surprises to ensure your instruments are operating to specification so you can rely on accurate measurements.



www.keysight.com/go/quality

Keysight Technologies, Inc.
DEKRA Certified ISO 9001:2008
Quality Management System



Keysight Channel Partners

www.keysight.com/find/channelpartners

Get the best of both worlds: Keysight's measurement expertise and product breadth, combined with channel partner convenience.

www.keysight.com/find/FieldFox

For more information on Keysight Technologies' products, applications or services, please contact your local Keysight office. The complete list is available at: www.keysight.com/find/contactus

Americas

Canada	(877) 894 4414
Brazil	55 11 3351 7010
Mexico	001 800 254 2440
United States	(800) 829 4444

Asia Pacific

Australia	1 800 629 485
China	800 810 0189
Hong Kong	800 938 693
India	1 800 11 2626
Japan	0120 (421) 345
Korea	080 769 0800
Malaysia	1 800 888 848
Singapore	1 800 375 8100
Taiwan	0800 047 866
Other AP Countries	(65) 6375 8100

Europe & Middle East

Austria	0800 001122
Belgium	0800 58580
Finland	0800 523252
France	0805 980333
Germany	0800 6270999
Ireland	1800 832700
Israel	1 809 343051
Italy	800 599100
Luxembourg	+32 800 58580
Netherlands	0800 0233200
Russia	8800 5009286
Spain	800 000154
Sweden	0200 882255
Switzerland	0800 805353
	Opt. 1 (DE)
	Opt. 2 (FR)
	Opt. 3 (IT)
United Kingdom	0800 0260637

For other unlisted countries:
www.keysight.com/find/contactus
(BP-04-23-15)