

Measuring Wireless Power Charging Systems for Portable Electronics

Application Note

What you will learn:

The focus will be on the Qi ("chee") interface as developed by the Wireless Power Consortium (WPC, <http://www.wirelesspowerconsortium.com/>) and how to use the MDO oscilloscope to make time-correlated measurements across the time and frequency domains.

Introduction

Mobile electronics can be found everywhere – homes, hospitals, schools, purses, and pockets. With the explosion in portability, consumers have come to expect and demand long battery life. Energy efficient design techniques and improved battery technologies have helped to extend battery life but recharging devices is still a necessary and sometimes burdensome task. Wireless power charging systems look to simplify how portable electronics are recharged by transmitting energy to the device without a physical connection. There are various implementations and standards for wireless charging but most use some form of electromagnetic induction. This application note will focus on the Qi ("chee") interface as developed by the Wireless Power Consortium (WPC, <http://www.wirelesspowerconsortium.com/>).

Unlike wireless telecommunication systems like radio or cellular phones, wireless power transmission depends

more on the efficiency of transfer than signal to noise ratio. From a measurement perspective, the chargers present many challenges to the designer. The Qi wireless charger is designed to produce 5 Watts of charging power, while the Energy Star goals require high operating efficiency and low standby power. The efficiency of power transfer is dependent on system design including both transmitter and receiver, specifically the interaction between each one. Designs typically target greater than 70% efficiency for a 5 Watt system. The selection of coils, shielding, components and physical design influence the overall system efficiency. This is more complicated in a wireless charging system than in a typical charger, since the wireless system requires both a transmitter and a receiver. Other complications exist due to the shielding requirements, necessary to protect sensitive electronics and the battery from the RF fields, and foreign object detection in order to prevent heating of nearby metal objects.

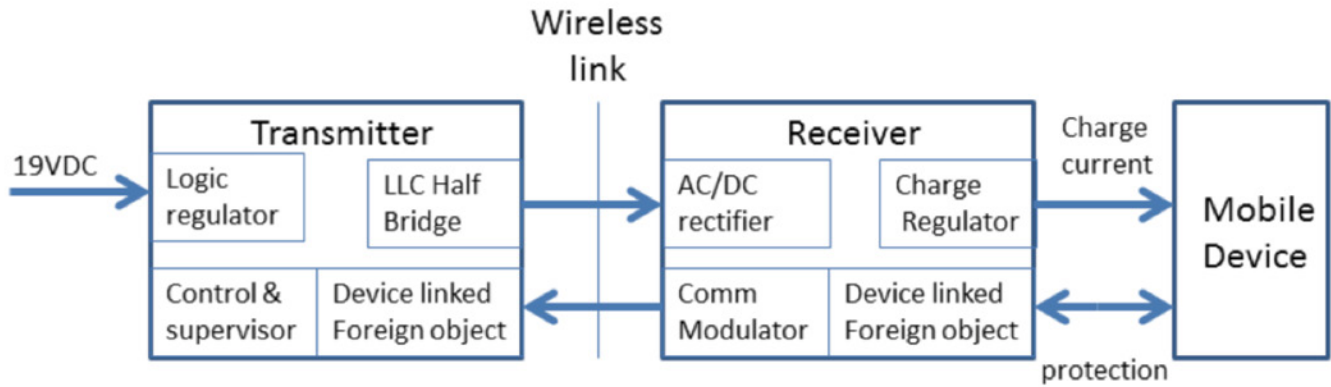

Figure 1. Qi Wireless Charging System Overview.

System Overview

While both interesting and challenging, the Qi system includes low frequency modulated RF, digital and analog circuits all on a single board. A simplified block diagram of the system architecture is shown in Figure 1. The charging system uses digital communication, both for JTAG debugging, and also for the purpose of transferring data between the secondary and primary circuits across the resonant link. The charger's output voltage is monitored by a secondary side microcontroller

that generates signals and uses modulation techniques to transfer information to the primary side. The information is demodulated on the primary side where it is interpreted by the primary side microcontroller. The modulated information is organized into information packets that have preamble bytes, header bytes, message bytes and checksum bytes. Per the WPC specification, information packets can be related to Identification, Configuration, Control Error, Rectified Power, Charge Status, and End of Power Transfer information.

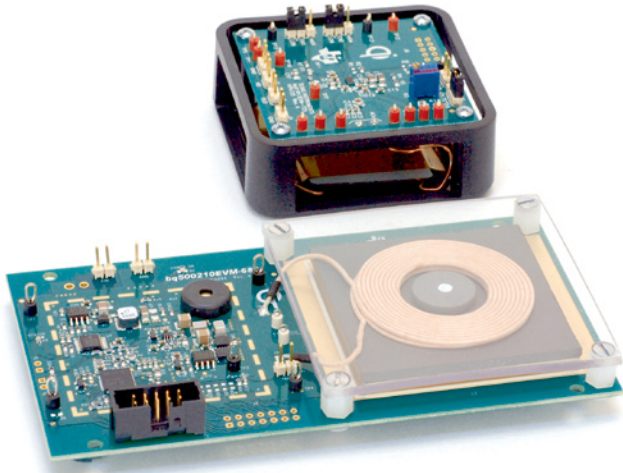

Figure 2. Texas Instrument Wireless Power Set, including a Bq500210EVM-689 transmitter and Bq51013EVM-725 receiver.

Setting Up the Measurement

The device we are testing is a Texas Instrument Wireless Power set, including a Bq500210EVM-689 transmitter and Bq51013EVM-725 receiver (See Figure 2). The transceiver and receiver system, in addition to transferring power, also transmits controls signals (modulated on top of the same RF power signal) from the secondary to the primary as well dynamically monitoring and controlling power levels to prevent overheating due to nearby metal objects.

The test setup is shown in Figure 3. The 19V, 0.5A DC input power is provided by a Tektronix PWS4323 programmable power supply. The MDO4104B-6 Mixed Domain Oscilloscope is used to make the measurements. This instrument provides 1 GHz bandwidth across four analog channels and includes serial packet decode for many industry standard control



Figure 3. Test setup for measuring the charger including a Mixed Domain Oscilloscope, voltage and current probes, laboratory-grade power supply, and signal injectors.

buses like Inter-IC (I²C) and Serial Peripheral Interconnect (SPI). It also includes an integrated spectrum analyzer capable of measuring RF signals up to 6 GHz. Control signals will be monitored via the analog input and the RF signal and its respective harmonics will be analyzed with the spectrum analyzer input channel. Note, due to the planar coupling and close proximity of the primary and secondary coils it is difficult to measure the energy transfer wirelessly. Consequently, the power will be measured on the secondary side with a high impedance voltage probe directly at the output.

The Qi charger power stage is based on a Half Bridge LLC topology resonant converter, controlled directly from the primary side charger controller. The resonant converter is frequency modulated over a frequency range of approximately 110 kHz to 205 kHz, as required by the WPC standard, in order to regulate the charger output power.

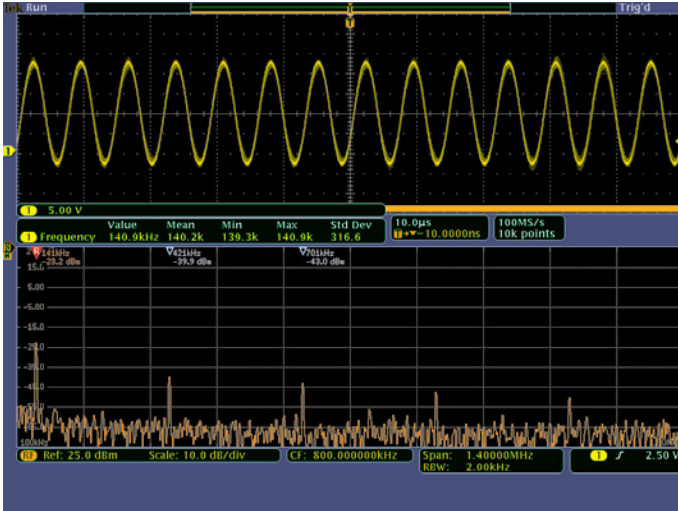

Figure 4. LLC half bridge resonant link current top trace, LLC half bridge switching spectrum lower trace.

There are several ways to look at the LLC resonant waveforms. Figure 4 shows a facsimile of the resonant link current, measured with a voltage probe connected to the resonant capacitor link at (TP2) and also shows the resonant frequency. This current could also be measured directly using a current probe or via the I_Sense testpoint on the transmitter board. The RF power signal (on the transmitter side) is measured with a voltage probe connected to TP1 via the Picotest J2180A preamplifier. The preamplifier provides a high input impedance and a 50 Ohm output impedance,

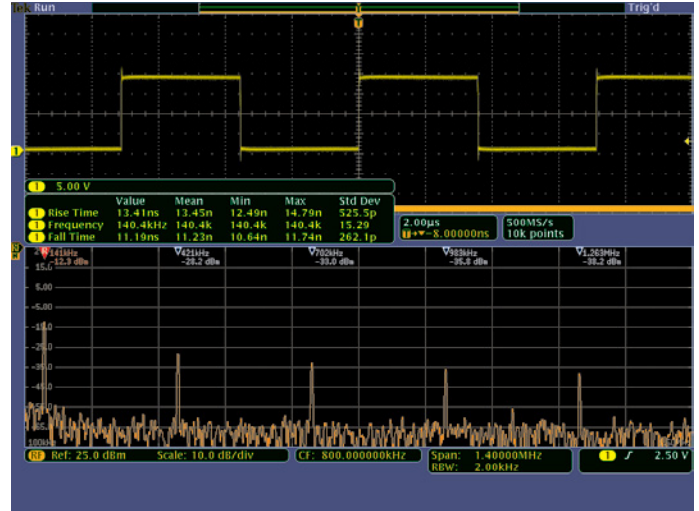

Figure 5. LLC half bridge switching voltage upper trace, LLC half bridge switching spectrum lower trace.

facilitating a voltage probe connection to the LLC half bridge switch node. The spectrum analyzer channel displays the fundamental operating frequency of 141 kHz and is also rich with the odd harmonics associated with the 50% duty cycle switch voltage. The lack of even harmonics provides assurance that the duty cycle is precisely 50%.

Figure 5 shows the LLC half bridge converter switch node on the upper analog trace confirming the 50% duty cycle waveform visually.

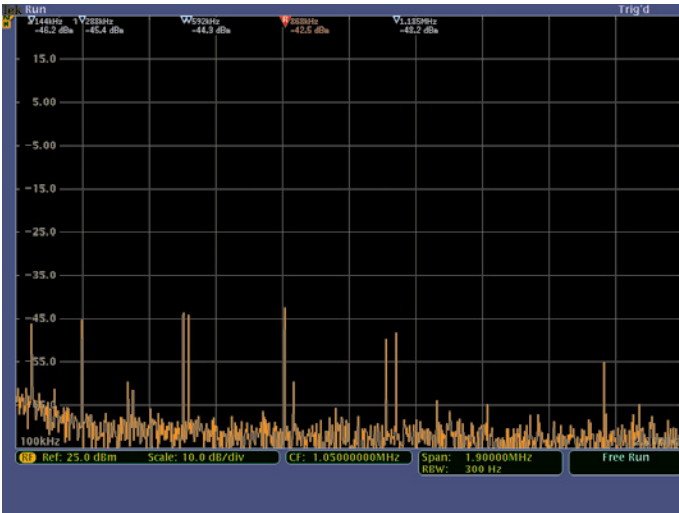

Figure 6. Radiated EMI signals from the LLC half bridge switches and the 600 kHz buck regulator.

The MDO is also used to measure higher frequency signals, such as EMI. Figure 6 shows the radiated EMI over a frequency range of 100 kHz to 2 MHz from the LLC half bridge switching, as well as from a low power 600 kHz buck regulator used to efficiently convert the 19VDC input voltage

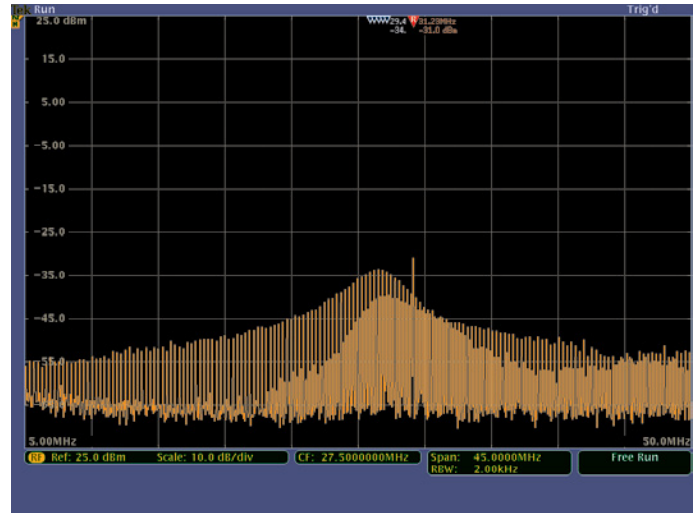

Figure 7. Radiated EMI signals from the LLC half bridge switches, 600 kHz buck regulator and 31 MHz microcontroller.

to 3.3V required by the transmitter controller. Figure 7 shows the radiated EMI signals from the LLC half bridge switches, 600 kHz buck regulator and 31 MHz microcontroller over a frequency range of 5 MHz to 50 MHz.

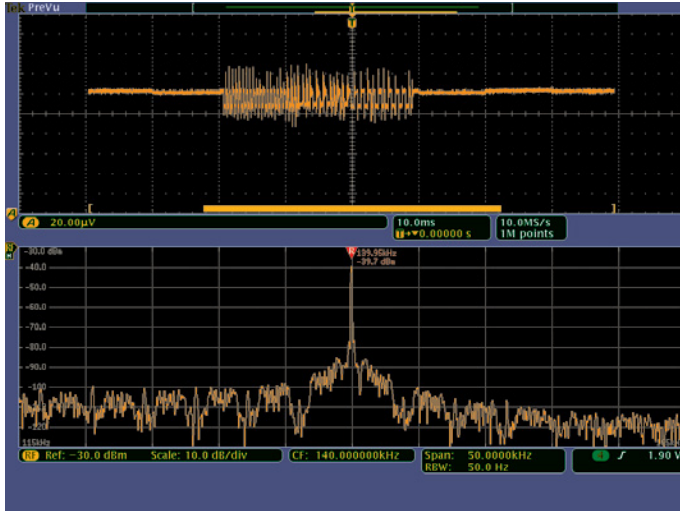

Figure 8. Spectrum analyzer input showing the spectrum of the LLC half bridge converter in the lower trace and the amplitude modulation, using the spectrum time amplitude vs time function to show the communication signals in the upper trace.

The digital communications across the resonant link are accomplished using either resistive or capacitive techniques. Either method results in an amplitude modulation of the primary voltage. The spectrum-time capabilities of the MDO4000B are used to show the time-varying nature of the modulation behavior, specifically with the amplitude vs. time waveform. The upper trace of Figure 8 shows the amplitude modulation signal while the lower half shows the resonant link signal in the spectrum view. The digital information can be extracted using either a voltage probe or a near field H probe, connected to the MDO4000B spectrum analyzer input via the Picotest J2180A preamplifier. For this application note we used a near field probe set from Electro-Metrics.

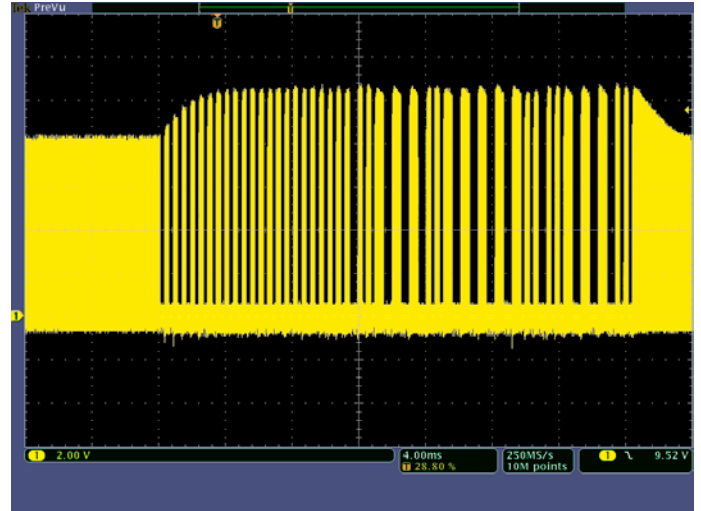

Figure 9. Receiver modulation control pin measured with the TDP0500 Differential probe.

The communication signals can be seen in the time domain. Figure 9 shows the communication modulation control signal, generated by the receiver controller while Figure 10 shows the amplitude modulation of the transmitter primary winding voltage. Both of these signals are measured using a TDP0500 differential voltage probe for maximum clarity and minimum circuit loading. The differential probe is more important in the measurement of the primary voltage than it is for the receiver controller voltage. This is due to the receiver control signal being ground referenced and relatively low impedance. The primary voltage is floating and, being part of the resonant tank circuit, the primary voltage is more sensitive to loading such as the input capacitance of voltage probes.



Figure 10. Primary coil voltage measured with the TDP0500 Differential probe.

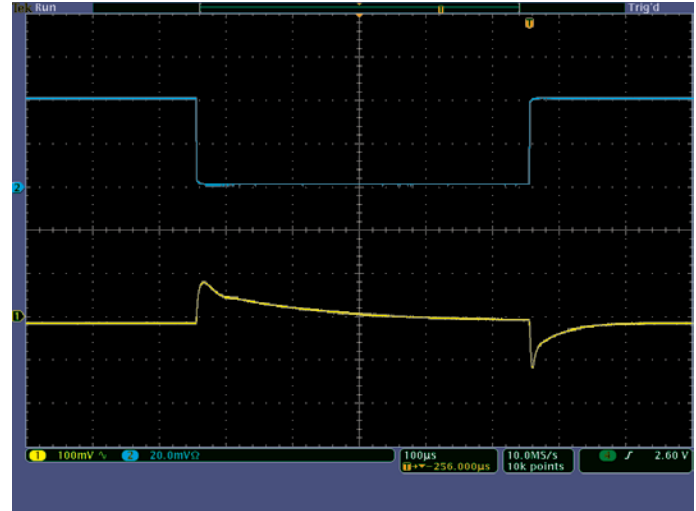

Figure 11. Dynamic load response of 5V output. Blue trace is current (20mA/Div) and yellow trace is voltage (100mV/Div).

The Qi charger ultimately provides a 5V, 1A output to charge portable electronic batteries. The LLC half bridge converter coarsely regulates the secondary side voltage. The output is then precisely regulated using a 5V low dropout regulator (LDO).

Figure 11 shows the result of a small signal step load applied to the 5V output, using a Picotest J2111A Current Injector, in order to measure the dynamic response and control loop stability of this final output regulator. The current injector is used in place of an electronic load to allow faster rise and fall times.

The primary value of a mixed domain oscilloscope is its ability to make time-correlated measurements across two domains; the time domain and the frequency domain. In addition, it can make these measurements between multiple analog, digital, and RF signals. Time-correlated means that the mixed domain oscilloscope can measure timing relationships between all of its inputs. It can, for instance, measure the time between a control signal and the beginning of a radio transmission,

measure the risetime of a transmitted radio signal, or measure the time between symbols in a wireless data stream. A power supply voltage dip during a device state change can be analyzed and correlated to the impact on the RF signal. Time correlation is critical for understanding the complete system operation: cause and effect.

Using the MDO4000B Mixed Domain Oscilloscope we were able to measure the logic, RF and analog functions of the Qi wireless battery charger, aided by a few probes and accessories. In the case of the communication signal, the MDO measured the signals in more than one domain. This included monitoring control signals, RF received output with a spectrum view as well RF amplitude vs. time. This allowed us to see the signal at its point of origin, within the RF link signal, and at the point of receipt across the transmitter winding. We also measured the analog step load performance of the final LDO output regulator and were able to capture the EMI signals.

Contact Tektronix:

- ASEAN / Australia** (65) 6356 3900
- Austria*** 00800 2255 4835
- Balkans, Israel, South Africa and other ISE Countries** +41 52 675 3777
- Belgium*** 00800 2255 4835
- Brazil** +55 (11) 3759 7627
- Canada** 1 (800) 833-9200
- Central East Europe and the Baltics** +41 52 675 3777
- Central Europe & Greece** +41 52 675 3777
- Denmark** +45 80 88 1401
- Finland** +41 52 675 3777
- France*** 00800 2255 4835
- Germany*** 00800 2255 4835
- Hong Kong** 400-820-5835
- Ireland*** 00800 2255 4835
- India** +91-80-30792600
- Italy*** 00800 2255 4835
- Japan** 0120-441-046
- Luxembourg** +41 52 675 3777
- Macau** 400-820-5835
- Mongolia** 400-820-5835
- Mexico, Central/South America & Caribbean** 52 (55) 56 04 50 90
- Middle East, Asia and North Africa** +41 52 675 3777
- The Netherlands*** 00800 2255 4835
- Norway** 800 16098
- People's Republic of China** 400-820-5835
- Poland** +41 52 675 3777
- Portugal** 80 08 12370
- Puerto Rico** 1 (800) 833-9200
- Republic of Korea** +822-6917-5000
- Russia** +7 495 664 75 64
- Singapore** +65 6356-3900
- South Africa** +27 11 206 8360
- Spain*** 00800 2255 4835
- Sweden*** 00800 2255 4835
- Switzerland*** 00800 2255 4835
- Taiwan** 886-2-2656-6688
- United Kingdom*** 00800 2255 4835
- USA** 1 (800) 833-9200

* If the European phone number above is not accessible,
please call +41 52 675 3777

Contact List Updated June 2013

For Further Information

Tektronix maintains a comprehensive, constantly expanding collection of application notes, technical briefs and other resources to help engineers working on the cutting edge of technology. Please visit www.tektronix.com



Copyright © 2013, Tektronix. All rights reserved. Tektronix products are covered by U.S. and foreign patents, issued and pending. Information in this publication supersedes that in all previously published material. Specification and price change privileges reserved. TEKTRONIX and TEK are registered trademarks of Tektronix, Inc. All other trade names referenced are the service marks, trademarks or registered trademarks of their respective companies.

