



4 Things to Consider When Using a Data Acquisition System

eBook

 KEYSIGHT

Introduction

There is a growing trend across all industries to design feature-rich products. The more features added to a product, the more complex the test development becomes.

So, how do you improve your test development cycle time, choose the right components and setup to optimize your test time, and improve the accuracy of your test system?

You need to achieve all these while meeting market windows and project deadlines. A data acquisition system (DAQ) could help you achieve all of these goals. In this e-book, you will learn about:

- The components that make up a data acquisition system
- The types of sensors or transducers that are available in the market that convert physical parameters into electrical signals
- Cables and types of connections that will improve the accuracy of your measurements
- The backend analog to digital conversion (ADC) choice of configurations and trade-offs
- An example of how to minimize errors along the entire temperature measurement path

Use this e-book as a guide when you develop your test systems. There are many links along the way that will help you get a more in-depth understanding of data acquisition systems.



Figure 1. DAQ970A mainframe data acquisition system and its input / output modules



Contents



CHAPTER 1

Data Acquisition System Overview



Data Acquisition System Overview

The need for a DAQ

The purpose of any data acquisition system is to gather useful measurement data for characterization, monitoring, or control.

When **performing product characterization**, you will likely need to:

- Measure multiple inputs, such as ten temperature points
- Measure multiple types of inputs, (e.g. voltage, current, temperature)
- Optimize test accuracy and measurement speed

When **monitoring a product or a process**, you will likely need to:

- Take readings periodically over time
- Compute the data while recording them into a file for post data analysis
- Trigger external alarm lights, sirens or control systems to take corrective actions

When **controlling your test process** is required, you will need to:

- Provide analog output signals to control actuators, motors
- Provide digital output signals to communicate with devices
- Route signals using a switching card to power or connect test signals to devices

Transducers will be discussed more under the physical-to-electrical section.

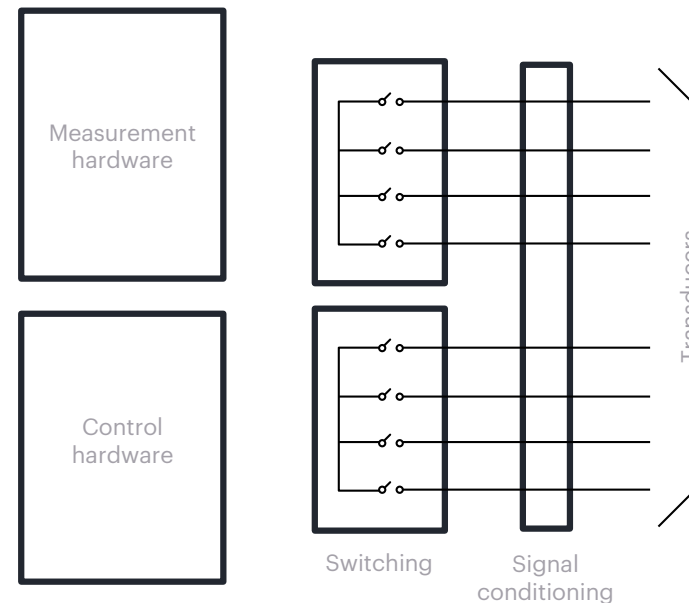

Figure 2.
Components of a typical DAQ system

Measurement hardware of a DAQ system

Measurement hardware is the input section of the DAQ system. It consists of analog inputs, digital inputs and counter inputs.

Analog inputs

Analog inputs are typically DC voltages acquired from the transducers. The measured voltages may correspond to a specific temperature, pressure, flow, or speed. The analog DC voltages are converted into digital data by the DAQ system's analog to digital converter (ADC). There are several types of ADC conversion techniques, generally divided into two types:

- Integrating
 - this technique measures the average input value over a defined time interval, thereby rejecting many noise sources
- Non-integrating
 - this technique samples the instantaneous values of the input signal (plus noise) during very short time intervals

Digital inputs

Some data acquisition systems contain a digital input card that detects a digital bit pattern to determine the status of an external device. Digital input cards typically contain 8, 16, or 32 channels that can be used to monitor a number of external devices. For example, a digital input card can be connected to an operator panel to determine the position of various switches on the panel.

Counter inputs

Some data acquisition systems contain a counter card that can be used to count events coming from an external device. For example, a counter card can be used to count the number of digital pulses (totalize), the duration of a digital pulse (pulse width), or the rate of digital pulses (frequency).

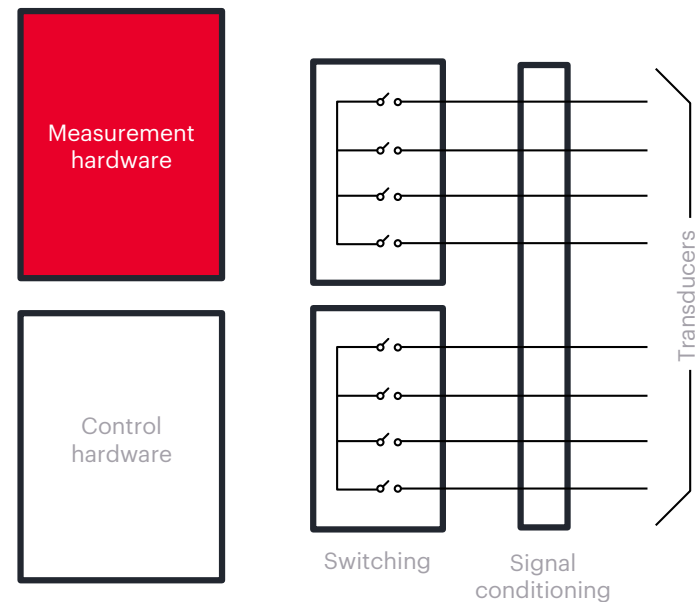

Figure 2a. Typical DAQ system. Measurement hardware block (as highlighted)

Control hardware of a DAQ system

Control hardware is the output section of the DAQ system. It mainly consists of analog outputs, digital outputs and control switching outputs.

Analog outputs

Some data acquisition systems contain a Digital to Analog converter (DAC) that performs the opposite function of an Analog to Digital converter (ADC). A DAC interprets commands from the control hardware and outputs a corresponding DC voltage or current. The output remains at this level until the control hardware instructs the DAC to output a new value. The voltage or current from the DAC can be used to control the speed of a fan, the position of a valve, or the flow rate of a pump. DACs are typically used in applications that require precise control of external devices.

Digital outputs

Some data acquisition systems contain a digital output card that interprets commands from the control hardware and outputs a corresponding digital bit pattern. A digital output card is typically used to control light indicators, or send digital control signals to external devices.

Control switching outputs

For control applications, a switching card can be used to supply power to external fans, pumps, or valves by completing an electrical circuit. The switch card (often referred to as an actuator) operates much like a switch to provide power to the external device. A switch card is typically used instead of a digital output card in those applications that require switching of high voltage and power.

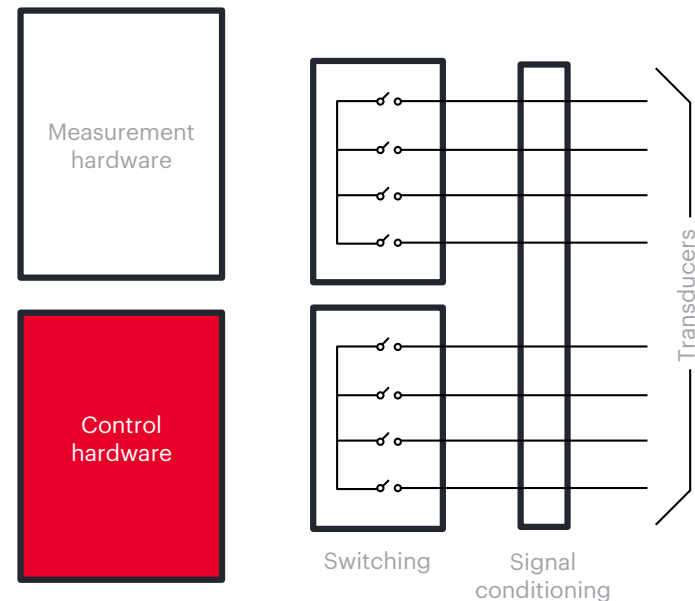

Figure 2b. Typical DAQ system. Control hardware block (as highlighted)

Switching and signal conditioning of a DAQ system

Switching hardware

Electromechanical switches, such as reed and armature relays, are common in low-speed applications. A key benefit is their ability to switch high voltage and current levels, but they are limited to switching rates of several hundred channels per second. Also, because they are mechanical devices, they will eventually wear out. Electronic switches, such as field-effect transistors (FETs) and solid-state relays, are typically used in high-speed applications. In addition to providing fast switching, they contain no moving parts and therefore do not wear out. The disadvantage of electronic switches is that they typically cannot handle high voltage or current, and must have high impedance to protect them from input spikes and transients.

Signal conditioning hardware

Signal conditioning amplifies, attenuates, linearizes, or isolates input signals from transducers before they are sent to the measurement hardware. Signal conditioning converts the signal to a form that is better measured by the system, or in some cases, makes it possible to measure the signal at all. Examples of signal conditioning (Figure 3) include:

- Amplification of small signals
- Attenuation of large signals
- Thermocouple compensation for temperature measurements
- Filtering to remove system noise

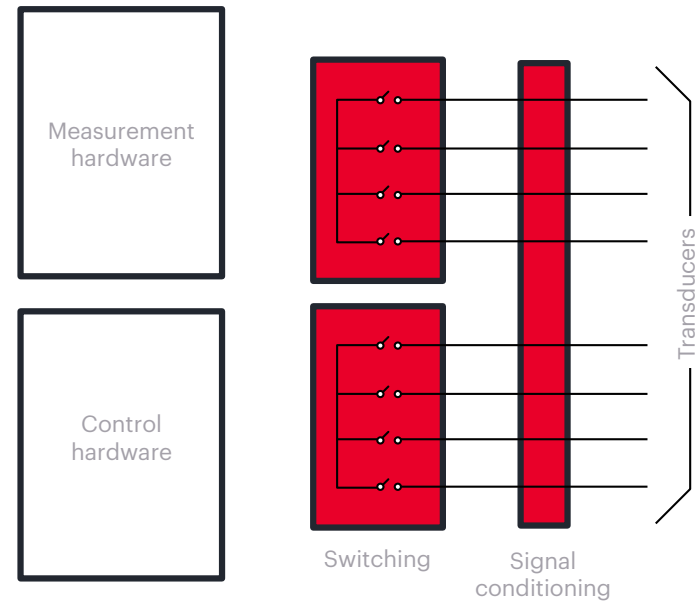

Figure 2c. Typical DAQ system. Switching and Signal Conditioning blocks (as highlighted)

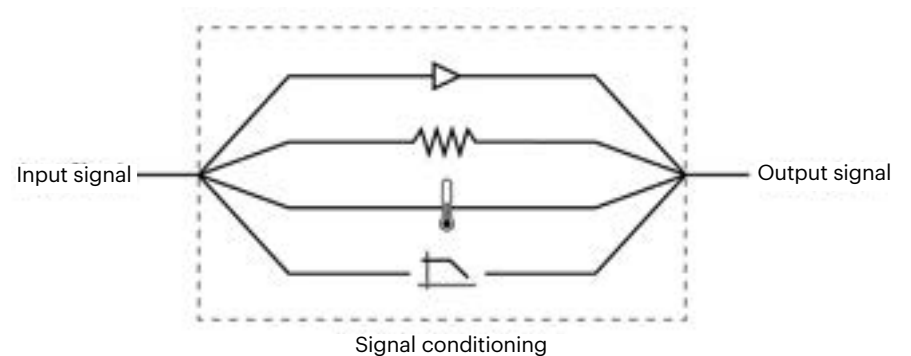
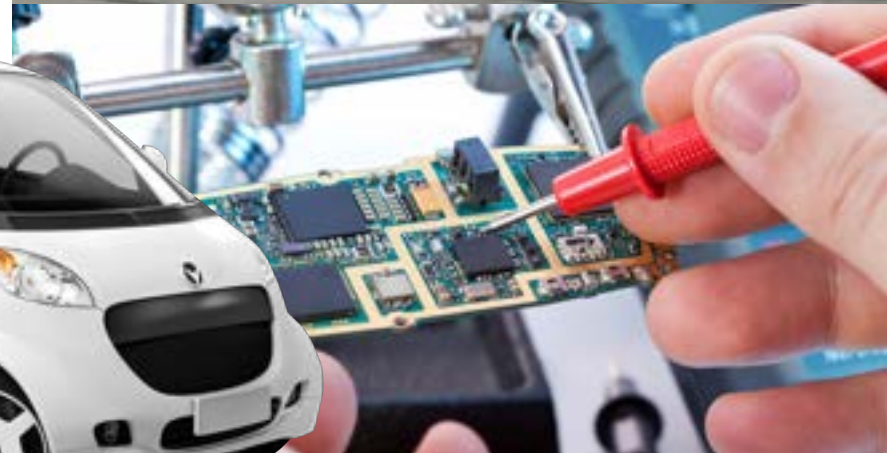

Figure 3. Simplified block of Signal Conditioning operation

Possible applications

Where are DAQs used?

- Temperature profiles of a chemical reactor
- Attenuation of satellite communication signals during rain
- Humidity measurements for food storage
- HVAC applications in smart buildings
- Electric car performance monitoring
- Cooling efficiency in refrigerators
- Thermal power lab heat transfer
- Tidal wave phenomena
- Solar energy studies
- Wind direction and velocity
- Battery and Fuel cell testing



What do all of these applications have in common?

Data logging and monitoring
Data profiling

Data acquisition system family

There are a few different types of DAQs. They each have roughly the same infrastructure, as outlined on the last few pages, but different form factors.

1. PXIe based DAQs have:

- High-speed measurements, multiple parallel synchronous measurements with the option to multiplex up to four times more channels
- High resolution
- Large input range
- Common in: aerospace defense, automotive industries

2. High-performance multifunction switch/measure units have:

- High scan rate of up to 1000 channels/sec
- Up to 560 2-wire channels or 4096 matrix cross-points in one mainframe
- Common in: large scale test systems across industries

3. General purpose DAQ and switch units have:

- Scan rate of up to 450 channels/sec, meets the requirements for many general applications
- Up to 120 2-wire channels
- Common in: small to medium scale test systems across industries

4. USB DAQs have:

- Lower performance, low cost solution
- Common in: education, small scale project test systems

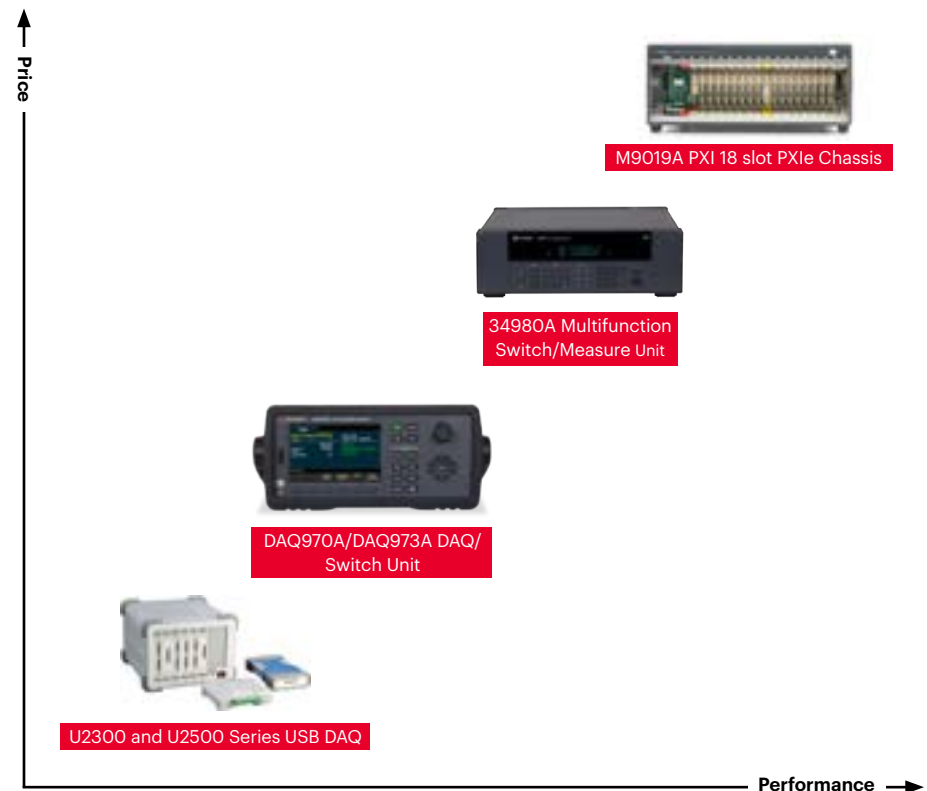
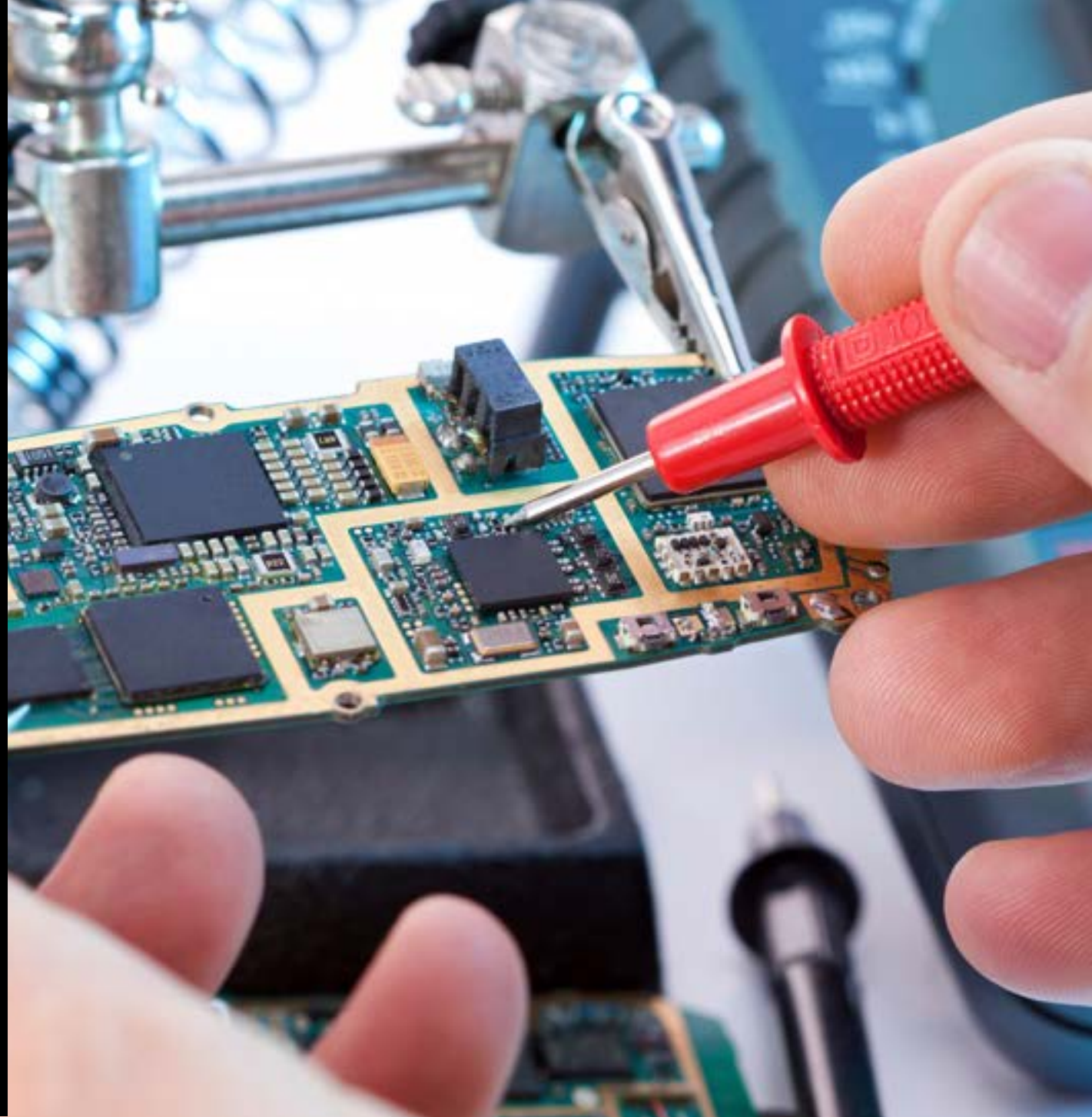

Figure 4. A complete DAQ family based on price/performance offering from Keysight. Keysight DAQ family offering meets a variety of price/performance needs



CHAPTER 2

Physical to Electrical Parameters



Convert Physical Parameters to Electrical Signals

Transducers (or sensors) are devices that transform physical parameters (such as temperature, flow, pressure, strain, and more) into electrical parameters (such as voltage, current, resistance, and more) - see Figure 5. The electrical parameter is measured by measurement hardware and the result is converted to engineering units. For example, when measuring a thermocouple, the measurement hardware actually reads a DC voltage, which it then converts to a corresponding temperature using a mathematical algorithm. Figure 6 shows several types of transducers with their corresponding outputs.

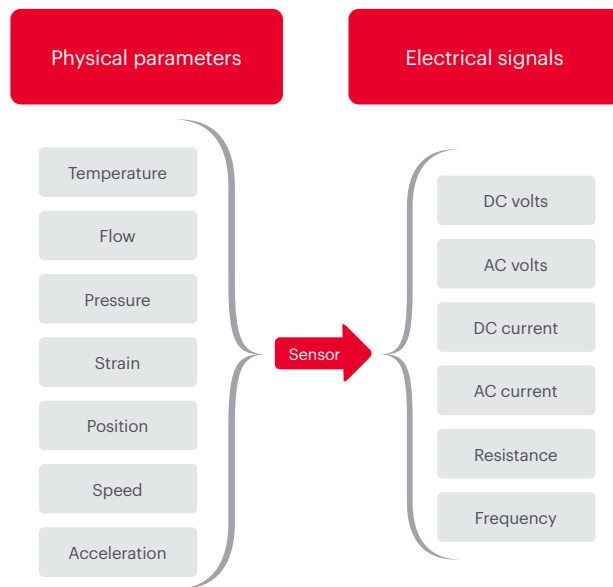

Figure 5. Physical parameters that convert to various electrical signals

Measurement	Software license	Support subscription
Temperature	Thermocouple	0 mV to 80 mV
	RTD	2-wire or 4-wire resistance from 5 Ω to 500 Ω
	Thermistor	2-wire resistance from 10 Ω to 1 MΩ
Pressure	Solid state	±10 Vdc
Flow	Rotary type	4 mA to 20 mA
	Thermal type	
Strain	Resistive elements	4-wire resistance from 10 Ω to 10 kΩ
Events	Limit switches	0 V or 5 V Pulse train
	Optical counters	
	Rotary encoders	
Digital	System	TTL Levels

Figure 6. Table of types of transducers with their corresponding outputs

Sensors, actuators, and transducers

Sensors are a type of *transducer* that converts a physical parameter to an electrical signal. We have discussed many types of sensors on the previous page, i.e. thermocouples, thermistors, rotary encoders, etc. Sensors can further be classified as passive or active sensors.

Passive sensors change their resistive, capacitive or inductive characteristics when its corresponding physical parameters change. They require an external power source to induce an electrical output. For example, a thermistor does not generate an electrical signal, but changes resistance corresponding to temperature changes. When electrical current is introduced across its resistance, an output voltage can be measured to detect temperature variations.

Active sensors generate electric current when the external physical environment changes. Examples of such sensors are the thermocouples, piezoelectric and photodiodes.



Thermocouple sensor



Piezo-electric sensor



Photodiode sensor

An **actuator** is the opposite of a sensor. It converts an electrical signal into a physical parameter, i.e. physical motion or sound. A data acquisition system can be equipped with analog or digital output signals to control an actuator to control temperature, control fluid flow, apply pressure or even to actuate motion using a motor. Sensors and actuators are often found working together. Cars are a prime example of this.

In a car, the sensor measures the oil flow, water temperature and so on. The data is fed to the car's computer, which analyzes the data and activates certain actuators. For cars with collision avoidance systems, the speed sensor and the radar feed data back into the car's computer. If the computer detects an impending collision, it will activate the actuators, in this case, the brakes, to slowdown the car.

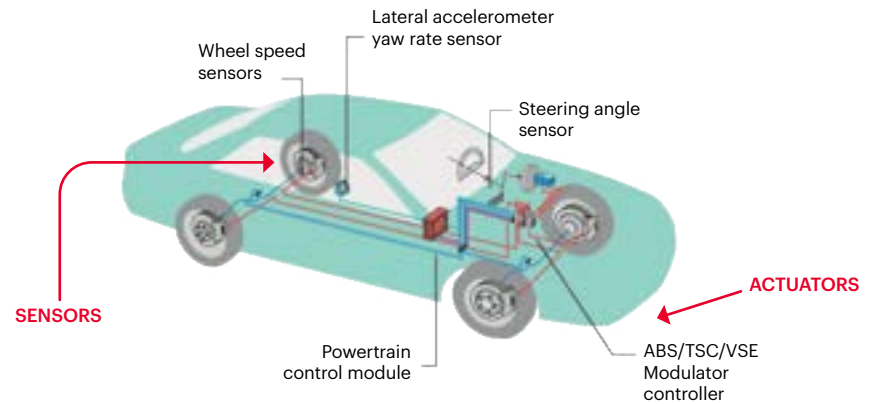

Picture from National Highway Traffic Safety Administration [NHTSA](#)

A comparison of types of temperature sensors

There are several temperature sensors from which to choose. The thermocouple, resistance temperature detector (RTD) and thermistor are three of the most common sensors used today.

The most commonly used temperature sensor is the thermocouple because of its versatility. It is made from two pieces of dissimilar wire, welded together in a bead. Thermocouples are low cost, extremely rugged, can be run long distances, are self-powered, and there are many types available to cover a wide range of temperature.

RTDs technically include thermistor devices, however, the term 'RTD' has come to stand for the specialized pure metal detector rather than the more generic semiconductor resistance element. RTDs are highly accurate and stable over long periods of time.

A thermistors is a device that changes its electrical resistance with temperature. They exhibit a negative temperature coefficient - as the temperature increases, the resistance of the element decreases.

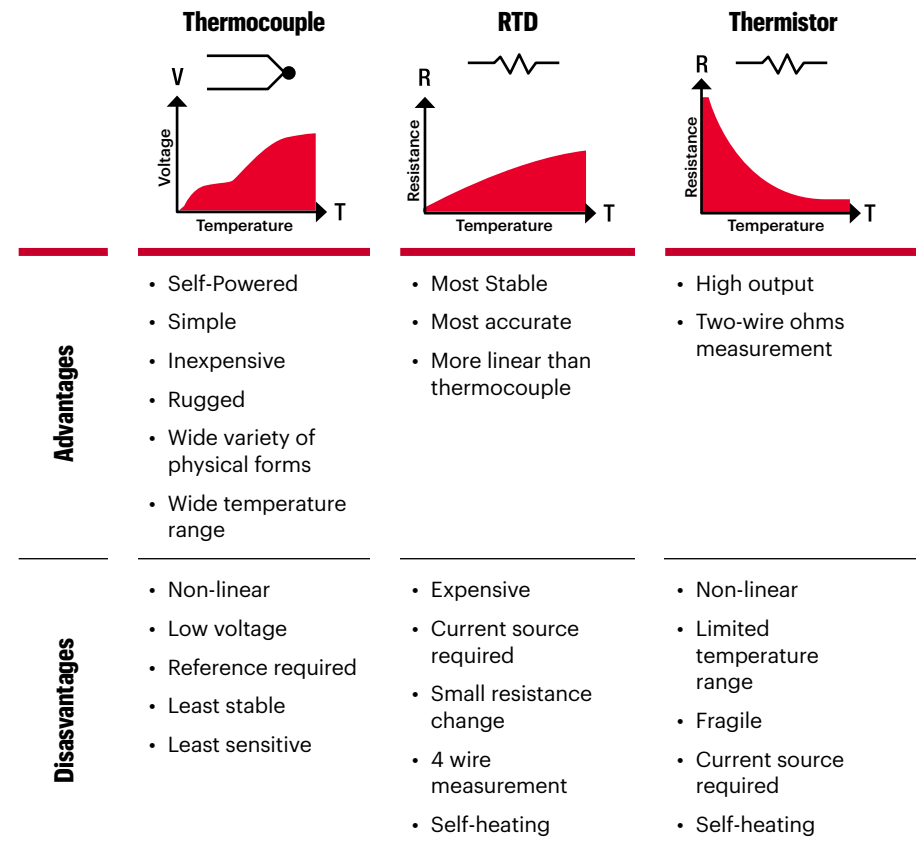
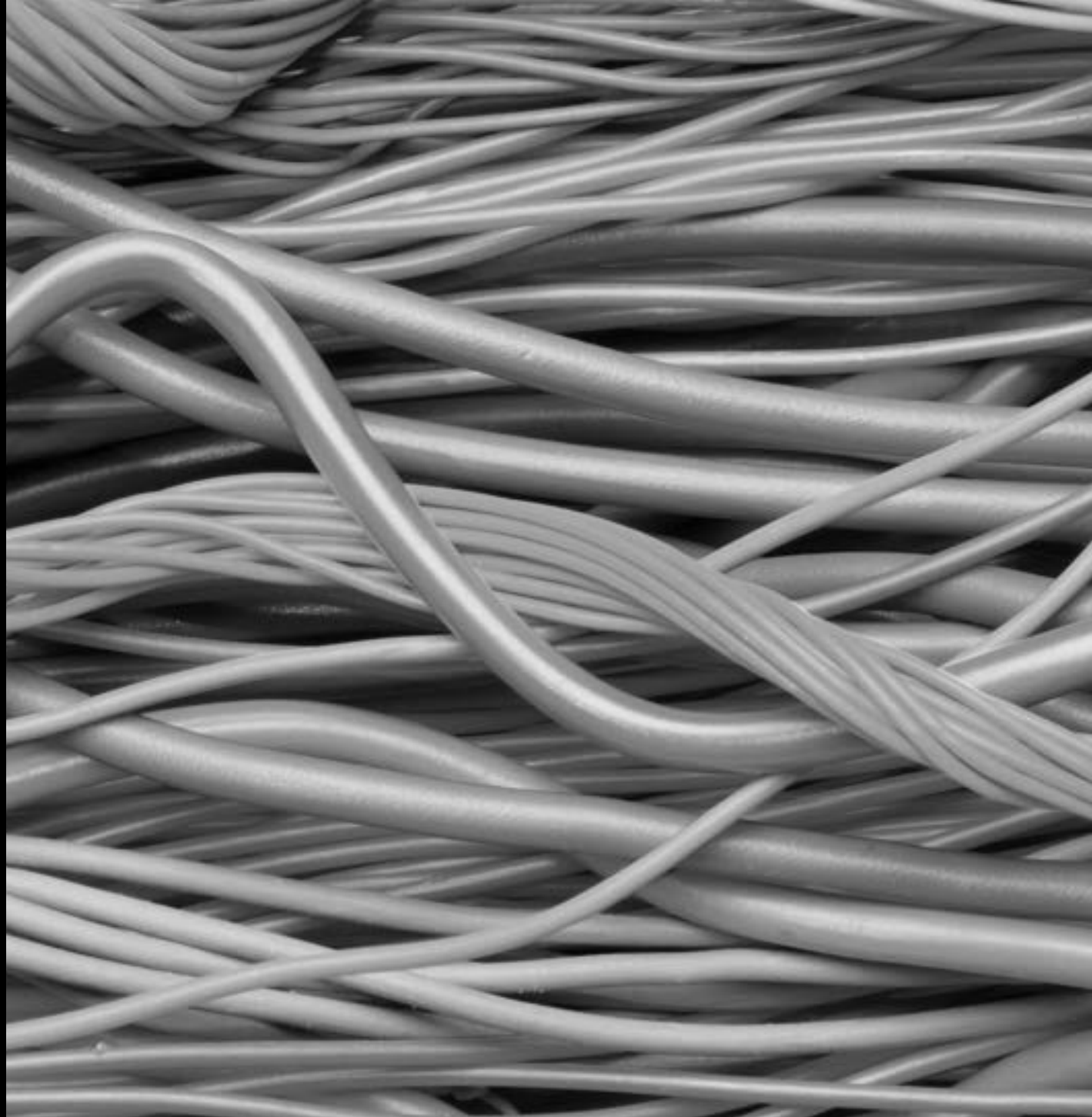

Figure 7. Temperature sensor type comparisons – advantages and disadvantages



CHAPTER 3

Cable and Input Connections



The Need for Shielded, Twisted Pairs

Once we've converted our physical phenomena to an electrical signal using a sensor, we want to send it to our instrument. We can have a lot of problems doing that, especially if we use the wrong cables or have improper connections. The main issue most people encounter is noise.

One way to reduce noise from our system is to **always use twisted pair shielded cables**. Each pair of wires in the bundle is twisted together, which reduces crosstalk interference from other wire pairs.

Shielding the wires reduces electromagnetic and radio frequency interference. Personal devices such as smart phones, laptops, or any electronic devices are sources of electro magnetic waves that can introduce noise to the electrical signal we want to measure in our instrument.

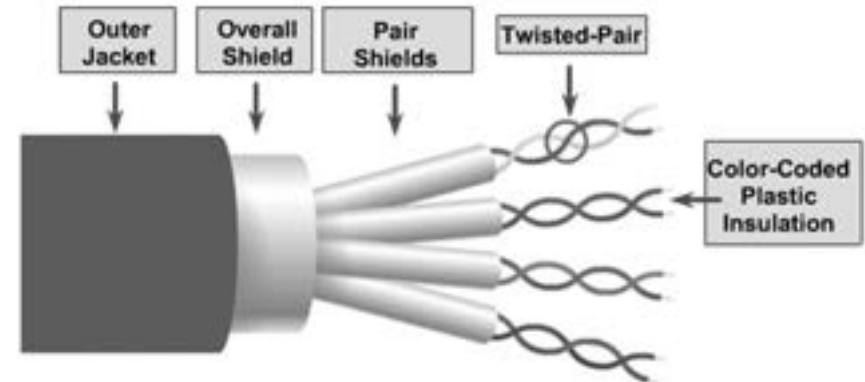

Figure 8. A diagram example of a twisted pair shielded cable

Something to think about:

We always use shielded cables for our audio equipment at home to get clean sound, why not do the same for our measurements at work?

The need for differential inputs

Cables and signal inputs to DAQs are either single-ended or differential inputs. There are obviously pros and cons in choosing either type of cable, but differential inputs have many advantages over single-ended cables. Differential signaling is usually used in conjunction with tightly twisted pair wires to reduce or cancel out the generation of electromagnetic noise. Hence, it has superior signal to noise ratio and fewer timing errors.

You will want to choose differential over single-ended for several reasons:

1. To reduce EMI or electromagnetic interference.
2. To reduce crosstalk or interference from nearby cables.
3. To transfer very low voltage signals, especially in millivolt range. Low voltage signals are susceptible to noise interference.
4. To transfer low voltage digital signals to save power.
5. To enable precise timing of digital signal crossover or digital switching.

Differential signaling has superior signal to noise ratio. It is usually used together with twisted pair cables.

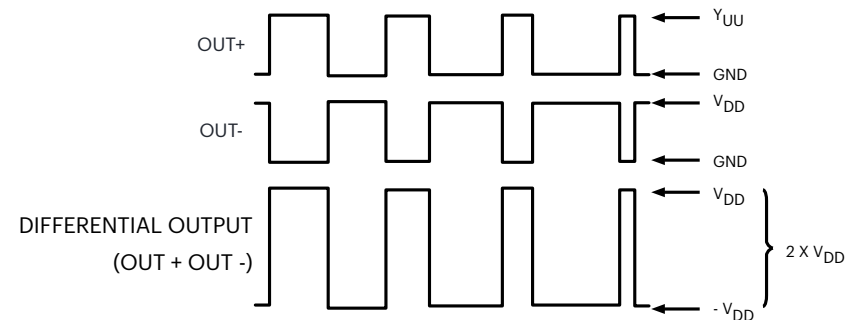

Figure 9. Differential output derived from two complementary signals (out+/out-)

The need for isolated inputs

Some data acquisition systems have built-in isolated inputs. So, what are the benefits of having isolated inputs?

1. Isolation provides safety to you, as a user, by applying barriers to keep high voltages away from you
2. Isolation breaks ground loops, which provides better measurement accuracy

What else should you know about isolation?

1. Isolation can be either digital or analog. Digital signals tend to have harmonics that can be detrimental to small analog signals and may get worse when amplified. Having isolation on either side can help make more accurate measurements.
2. Some DAQ systems will indicate the type and extent of isolation built-in to the instrument. Some isolations can be channel-to-channel or channel-to-earth.

Isolated inputs provide a safety barrier, break ground loops and prevent crosstalk between channels

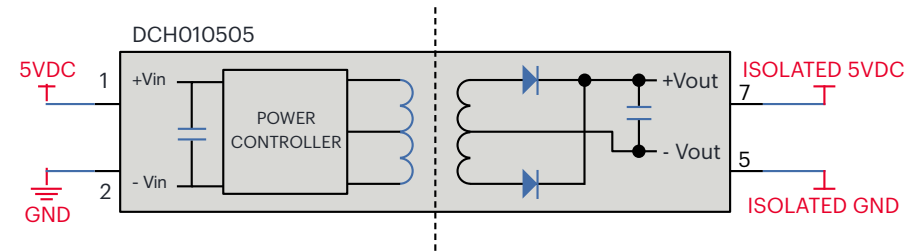

Figure 10. Isolated input circuit diagram

The need for noise rejection - power line

One of the major noise sources traveling across cables comes from power line sources (Figure 11). We have discussed several ways of removing or reducing noise such as differential signaling, use of twisted pair shielded cables and isolated inputs. Let's discuss another method of rejecting power line noise.

Some DAQ systems have built-in integrating analog-to-digital converters. These A/D converters can reject power line noise, this is called normal mode rejection (NMR). It does this by measuring the average DC input (integrating over a fixed period). This period is normally larger than the power line cycle (PLC).

If you set the integration time period to an integer value of the power line cycles of the spurious input, these errors (and their harmonics) will average out to approximately zero.

There is a trade-off between number of PLCs and measurement speed. Increasing the number of PLCs means a longer A/D integration time. Essentially, you get better NMR at the expense of measurement speed.

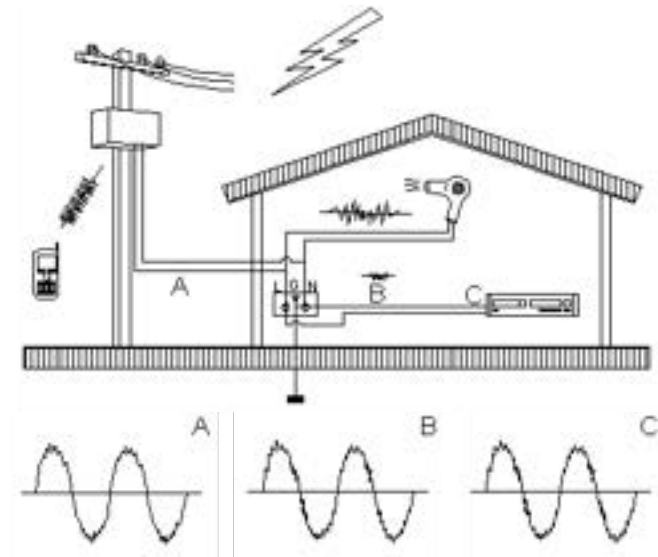

Figure 11. Power line noise coming from various sources

Digits	NPLCs	Integration Time 60 Hz (50Hz)	NMR
4½ Fast	0.02	400.7 µs (400 µs)	-
4½ Slow	1	16.7 ms (20 ms)	60 dB
5½ Fast	0.2	3 ms (3 ms)	-
5½ Slow	10	167 ms (200 ms)	60 dB
6½ Fast	10	167 ms (200 ms)	60 dB
6½ Slow	100	1.67 sec (2 sec)	70 dB

Figure 12. An example of a DAQ system's PLC setting measurement table

The need for noise rejection - ground loops

Noise rejection is important, especially for minimizing the effects of ground loops. Ground loops occur if the device under test (DUT) and DAQ or multimeter are referenced to a common earth ground. If any voltage appears between the two ground reference points, this voltage will manifest itself as an error in the measurement. The circuit in Figure 13 shows a voltage appearing between the DMM and DUT ground references. This voltage ground causes current to flow through the LO measurement lead between the two ground leads, leading to offset voltages and noise. This causes an error voltage (V_L) which leads to inaccuracies in the multimeter's measurement.

So, how do you minimize V_{ground} or ground noise voltage?

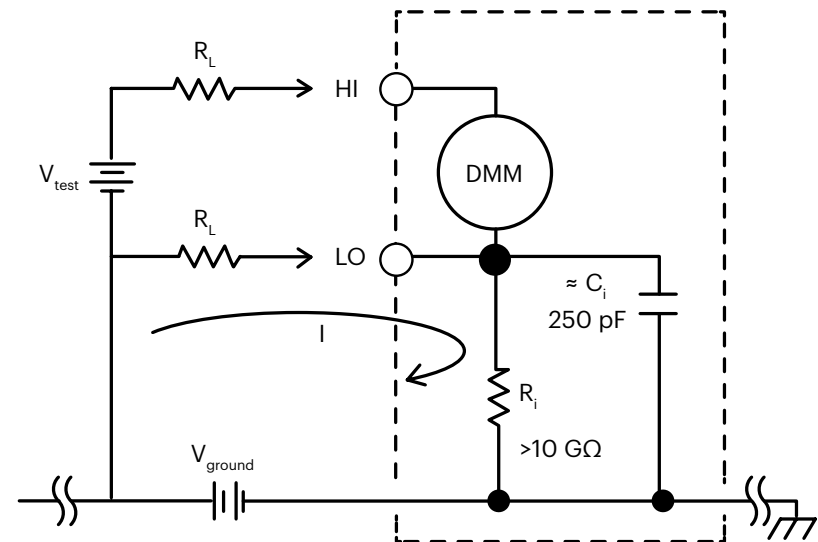

- R_L = Lead resistance
- R_i = DMM Isolation resistance
- C_i = DMM Isolation capacitance
- V_{ground} = Ground noise voltage
- I = Current flow caused by $V_{ground} = \frac{V_{ground}}{R_L + Z}$
- $Z \approx Z_{Ci} = \frac{1}{2\pi f C} \approx 10M\Omega$ at 50 or 60Hz
- V_L = $I \times R_L$

Figure 13. Illustration of how a ground loop happens during measurement

1. Use a large DMM isolation resistance. For DC ground loops, as long as the DMM isolation resistance (R_i) is a large value (meaning air between the two potentials), the error will be fairly insignificant when measuring mV and up.
2. Keep the ground path of low-level signals as short as possible. This works for DC ground loops.
3. The bigger source of noise and error from ground loops is the AC component. In most low-frequency applications, ground loop noise comes from the 50 or 60 Hz power line. Use the DMM's A/D integrator to remove the normal mode noise.
4. If your testing environment consists of high-frequency signals, high-speed digital signals, or noisy components like relays or motors, it is best to put any sensitive voltage measurements on a separate ground potential.



CHAPTER 4

Turning Analog into Digital

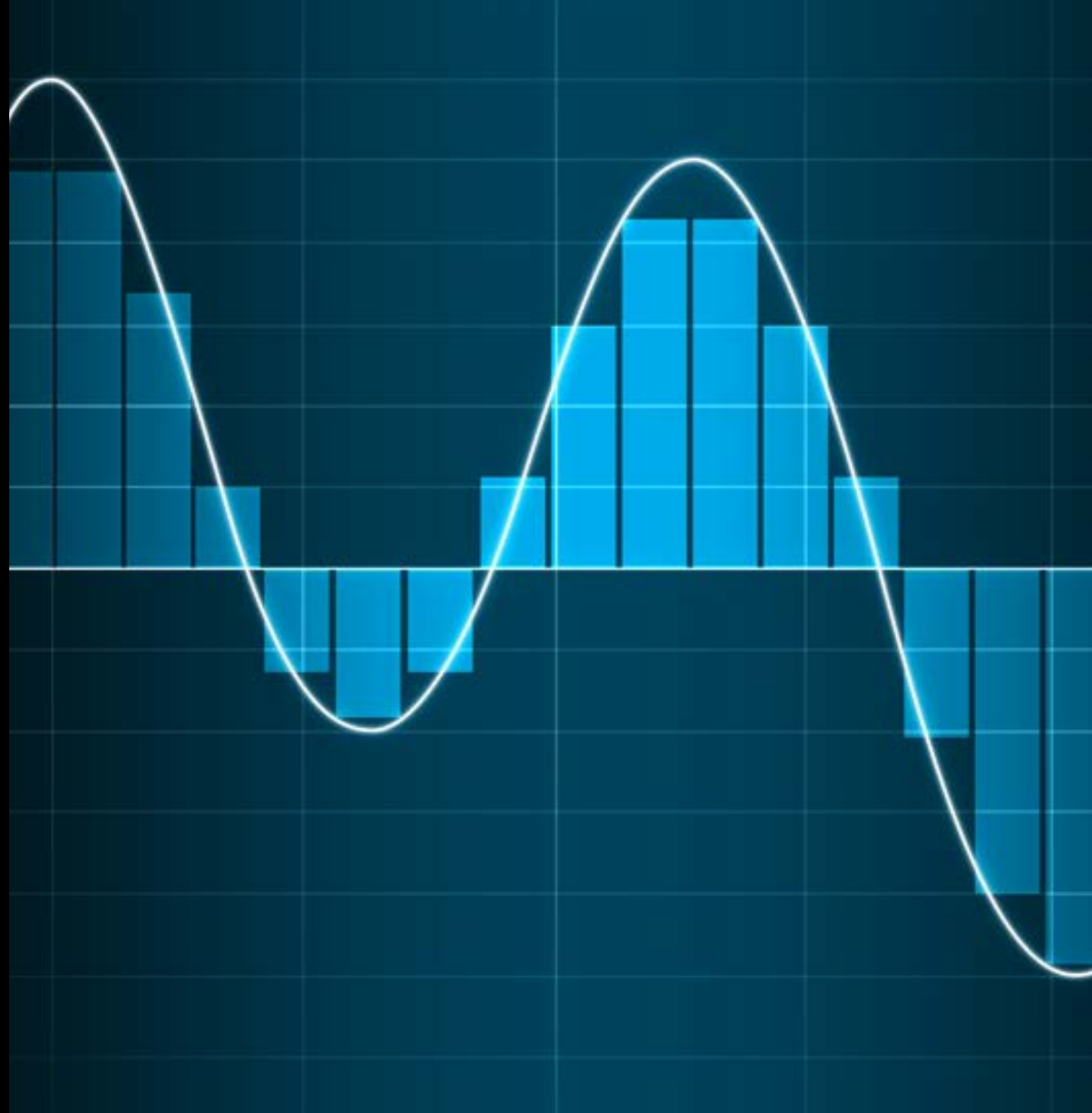

Things That Affect Measurement Fidelity

When making measurement settings, you always want to make sure measurements are high fidelity. This means your instruments and measurements have a high degree of accuracy and resolution.

Another important consideration when adjusting measurement settings is the measurement speed. However, there is no button or knob on an instrument to dial the speed up or down. Measurement speed is often affected by other measurement settings. These settings include resolution, use of averaging, calibration, the degree of noise reduction, and more.

So, accuracy, speed and resolution interact with each other and affect measurement fidelity.

Measurement fidelity refers to the degree of accuracy and resolution of your measurement.

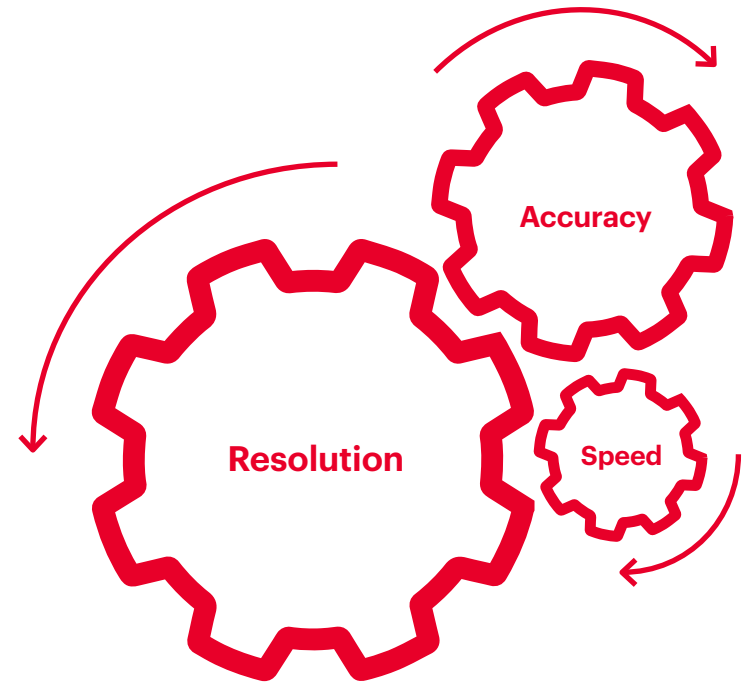

Accuracy and resolution

Here is a voltage measurement from a DAQ system that shows us how accuracy relates to resolution. See illustration in Figure 14.

- Resolution is the level of detail that can be measured, or the number of significant digits.
- Accuracy is a measure of how good these numbers are, or how much you can trust them.

Lets look at the last digit in our example (Figure 15), the number "7". As we are on the 100 mV range, the number "7" represents 700 nV. So on 100 mV range, we have a resolution of 100 nV.

However, is the actual value really 700 nV? Maybe. The closeness of 700 nV from the actual value is what we call accuracy. So, having a higher resolution doesn't necessarily mean you have higher accuracy.

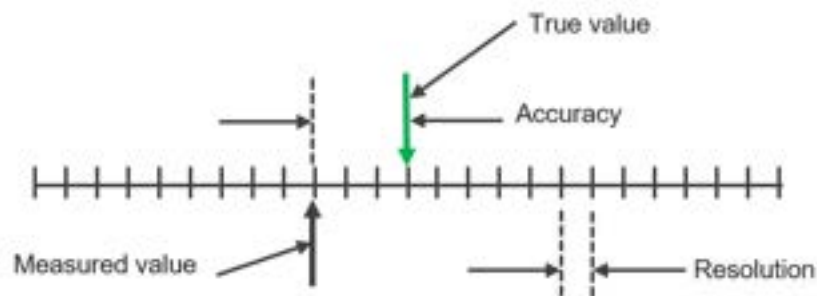

Figure 14. Shows a resolution scale and accuracy of measured value compared to true value

A 6.5 digit voltmeter with poor accuracy is no better than a 5.5 digit voltmeter with good accuracy.



Figure 15. Lowest voltage resolution measured by this DAQ system

How speed affects resolution

How about speed? What is its relationship with resolution?

Speed is how fast an ADC captures samples of data, or a measure of the amount of time between samples. Figure 16 is a comparison between Keysight's multimeters with the 'Other' brand multimeter to explain how speed affects resolution.

In the graph, the Keysight DAQ970A (with an integrated 6.5 digit DMM) is represented by the blue line, and the Keysight's 34470A (7.5 digit multimeter) is represented by the red line. The 'Other' line is a DAQ with a 7.5 digit multimeter, and is represented by the green line. You can see the green's resolution drops quickly when the sampling speed increases. Above speeds of 300 samples/second, the 'Other' competitor's 7.5 digit multimeter's resolution is the worst of the three.

So, resolution decreases when ADC sampling speed increases. Check the data sheet to determine the resolution of a DAQ across all speeds, and that the highest required speed of the DAQ actually meets your resolution requirements.

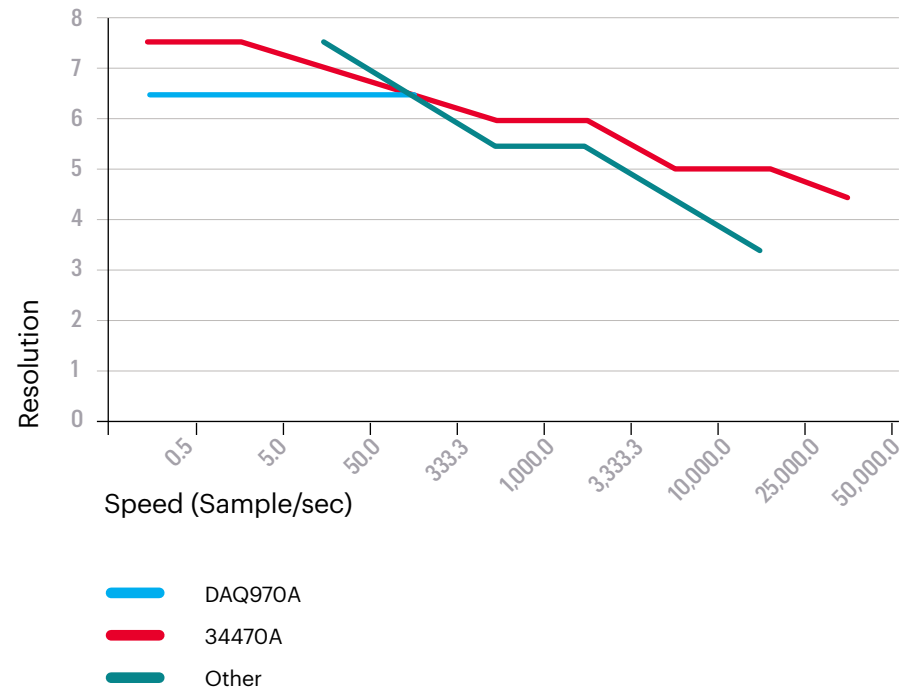

Figure 16. Lowest voltage resolution measured by the voltmeter of this DAQ system

The effect of sensitivity on resolution

Sensitivity is the smallest change of the measured signal that can be detected. It depends on both resolution and the lowest measurement range of the instrument. Using the correct range is very important for measuring the smallest change in the signal. The lower the range, the smaller the change we can detect.

For example in Figure 17a, the sensitivity of a DAQ multimeter on the 10 V range is 10 μ V. (The last digit is the ten-microvolt digit).

However, in Figure 17b, the sensitivity of the same DAQ multimeter on the 300 V range is 1000 μ V or 1 mV. (Based on the last digit).

Hence, you can lower your range to the lowest without ‘overloading’ error (measurement exceeding range), which maximizes your measurement sensitivity.

Use the correct range to ensure you can measure the smallest change in the measured signal

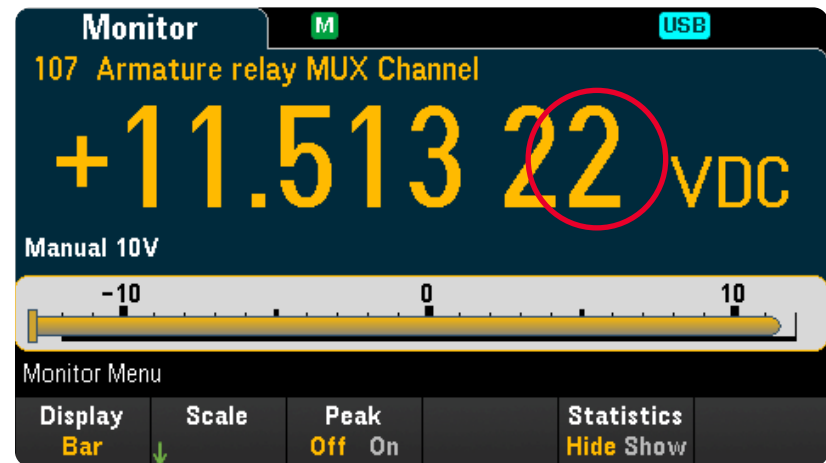

Figure 17a. Lowest voltage resolution (sensitivity) at 10 V range

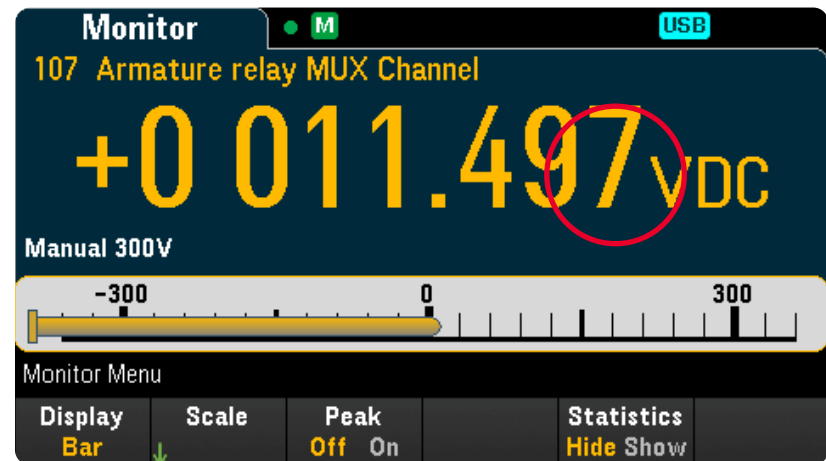

Figure 17b. Lowest voltage resolution (sensitivity) at 300 V range



CHAPTER 5

Summary



Summary

To summarize, let's use the temperature accuracy of a thermocouple as an example to illustrate why it is important to look at everything along the measurement path.

While the thermocouple seems like a simple sensor with two wires connected at one end used for measurement. However, to get an accurate measurement of the voltage at the thermocouple junction, several things need to be considered.

1. We need to make sure the thermocouple is properly constructed and that it has the right accuracy for the job.
2. We need a cold junction reference to eliminate the thermocouple effect at the connection point to the DAQ terminals.
3. The need to convert the non-linear voltage measurements from the thermocouple into temperature readings. A mathematical function will have to be built into the DAQ to convert the non-linear voltage readings into temperature.

To improve accuracy, we will need to consider each component of the DAQ system, from the sensor, to the cable, to the signal conditioning and to the ADC. An error or fault in any of these stages will give inaccurate results.

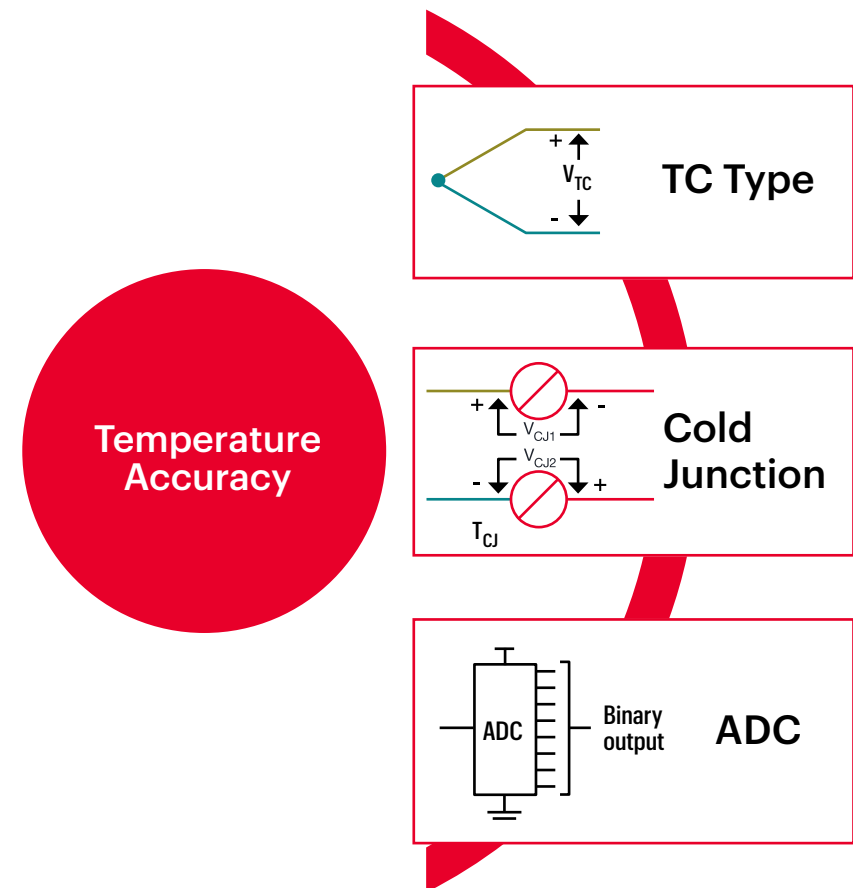
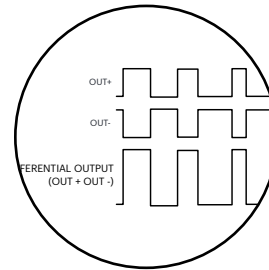

Figure 18. Reduce errors along the temperature measurement path

Key learnings



Choose a sensor that matches the behavior of the physical phenomenon



Use a measurement device that has differential inputs

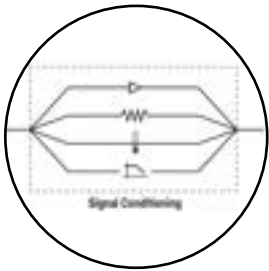

Apply the appropriate signal conditioning, if needed

Resolution Time	NMR
400.7 μ s (400 μ s)	-
16.7 ms (20 ms)	60 dB
3 ms (3 ms)	-
167 ms (200 ms)	60 dB

Use a measurement device that has noise rejection

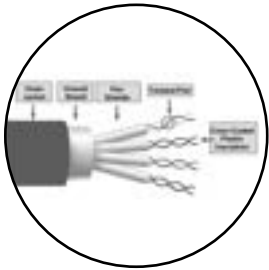

Use shielded, twisted pair cables, especially in noisy places

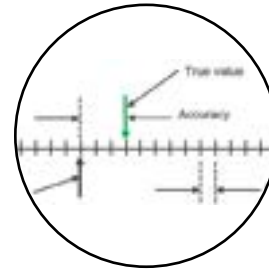

Use a measurement device that optimizes its resolution

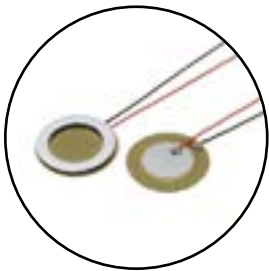

Choose a measurement device with amplitude ranges and frequency bandwidth to match the physical phenomenon

The Keysight DAQ970A/DAQ973A Data Acquisition System

- Built-in 6 ½ digit DMM allows you to measure very low current ranges (1 μ A DC and 100 μ A AC) and higher resistance ranges (1000 M Ω).
- Fast time to insight measuring multiple signal types and sensors. Data acquisition is easy to configure and run, with no programming required.
- A solid state multiplexer with faster switching speed (on top of 7 existing modules).
- BenchVue DAQ application software. The ability to easily configure measurements and test automation without programming.
- Built-in internal module calibration reduces thermal voltage offset errors.
- Higher performance and flexibility while maintaining compatibility with the 34970A/72A.



To stay up to date with the most recent tutorials, techniques, and best practices follow the Keysight Bench Facebook Page, check out the Keysight Labs YouTube channel, and follow that Keysight oscilloscopes guy on Twitter.

For more information about DAQ970A / DAQ973A, please go to:
www.keysight.com/find/daq



Keysight enables innovators to push the boundaries of engineering by quickly solving design, emulation, and test challenges to create the best product experiences. Start your innovation journey at www.keysight.com.

This information is subject to change without notice. © Keysight Technologies, 2019 – 2023, Published in USA, April 10, 2023, 5992-3179EN